

United States
Environmental Protection
Agency

Office of Solid
Waste and
Emergency Response

Technology Innovation Office
EPA/542/R-92/005
October 1992



CERCLA/SUPERFUND Orientation Manual



CERCLA /Superfund Orientation Manual

U.S. Environmental Protection Agency

Office of Solid Waste and
Emergency Response
Technology Innovation Office
401 M Street, SW.
Washington, D.C. 20460

NOTICE

Development of this document was funded by the United States Environmental Protection Agency. It has been subjected to the Agency's review process and approved for publication as an EPA document.

The policies and procedures set out in this document are intended solely for the guidance of response personnel. They are not intended, nor can they be relied upon, to create any rights, substantive or procedural, enforceable by any party in litigation with the United States. EPA officials may decide to follow this guidance, or to act at variance with these policies and procedures based on an analysis of specific site circumstances, and to change them at any time without public notice.

Word-searchable version – Not a true copy

FOREWORD

In 1980 Congress passed a law called the Comprehensive Environmental Response, Compensation, and Liability Act (CERCLA), commonly referred to as Superfund. The law authorizes the Federal government to respond directly to releases, or threatened releases, of hazardous substances that may endanger public health, welfare or the environment. CERCLA also enables EPA to take legal action to force parties responsible for causing the contamination to clean up those sites or reimburse the Superfund for the costs of cleanup. If those responsible for site contamination cannot be found or are unwilling or unable to clean up a site, EPA can use monies from the Superfund to clean up a site. In 1986, CERCLA was updated and improved under the Superfund Amendments and Reauthorization Act (SARA).

The Office of Solid Waste and Emergency Response (OSWER) has the responsibility for developing policy and implementing Superfund response activities. The OSWER is comprised of several offices. The Office of Emergency and Remedial Response (OERR) is responsible for national policy, regulations and guidelines for the control of hazardous waste sites and response to and prevention of oil and hazardous substance spills. The Office of Waste Programs Enforcement (OWPE) provides guidance and support for the implementation and enforcement of CERCLA, Resource Conservation Recovery Act (RCRA), Oil Pollution Act (OPA) and the Emergency Planning and Community Right-to Know Act (EPCRA). The Office of Solid Waste (OSW) is responsible for a management system for hazardous and solid waste. The Office of Underground Storage Tanks (OUST) is responsible for administering the Leaking Underground Storage Tank (LUST) Trust Fund. The LUST Trust Fund is available to States to help them clean up leaks from underground petroleum storage tanks provided that certain conditions for use of the fund have been met. The Superfund Revitalization Office's (SRO) goals are to accelerate the pace of cleanup actions, improve contracts management, and communicate progress and build public confidence in the Superfund program. The Chemical Emergency Preparedness and Prevention Office (CEPPO) has responsibility for EPCRA, enacted as Title III of SARA and for the accidental release provisions for the Clean Air Act (CAA). The Technology Innovation Office (TIO) promotes the use of innovative treatment technologies to permanently clean up contaminated sites in the Superfund, RCRA, and Underground Storage Tank programs.

The "[CERCLA/Superfund Orientation Manual](#)" serves as a program orientation guide and reference document, and it is designed to assist EPA and State personnel involved with hazardous waste remediation, emergency response, and chemical and emergency preparedness. The Manual describes the organizational and operational components of the Superfund Program.

As the Superfund Program enters its second decade, EPA is identifying and responding to long-term needs of the program. This process includes a program (Superfund 2000) to study the possible universe of sites, technologies, and opportunities for further integration with other EPA programs. EPA is also piloting a new plan, called the Superfund Accelerated Cleanup Model (SACM) designed to prioritize risk reduction and take remedial action in shorter timeframes and enable better communication of program accomplishments to the public.

The Technology Innovation Office extends special thanks, and acknowledgments, to the individuals (listed on the following page) who assisted in the compilation of this material, reviewed the draft sections, and provided comments.

Henry L. Longest II, Director /s/
Office of Emergency and Remedial Response

Walter W. Kovalick, Jr., Ph.D., Director, /s/
Technology Innovation Office

Timothy Fields, Jr., Director, /s/
Superfund Revitalization Office

Bruce M. Diamond, Director, /s/
Office of Waste Programs Enforcement

ACKNOWLEDGMENTS

This manual was developed by the Technology Innovation Office of the Office of Solid Waste and Emergency Response (OSWER). Special thanks to the following individuals in EPA who reviewed the drafts and provided valuable comments:

Technology Innovation Office (TIO) — Michael Forlini, Marlene Suit

Office of Emergency and Remedial Response (OERR) — George Alderson, Joan Bames, Steve Caldwell, Rhea Cohen, Bruce Engelbert, James Fary, Janet Grubbs, Jeff Langholz, Marsha Lindsey, Tina Maragousis, Robert Myers, Paul Nadeau, Carolyn Offutt, Bruce Patoka, John Riley, Karen Sahatjian, Thomas Sheckells, Susan Sladek, Dana Stalcup, Richard Troast, Suzanne Wells

Office of Waste Programs Enforcement (OWPE) -- Tracy Back, Kathryn Boyle, Frank Finamore, Julie Klaas, Bruce Kulpan, Alice Luddington, Betsy Smidinger, Cecilia Smith, Deborah Thomas

Office of Solid Waste (OSW) — Anne Price

Chemical Emergency Preparedness and Prevention Office (CEPPO) — Kimberly Jennings

Office of General Counsel (OGC) — Charles Openchowski, Lawrence Starfield, and other OGC staff

Office of Federal Facilities Enforcement (OFFE) — Sally Dalzell

Region 10 – Judith Schwartz

This document has been reviewed by the U.S. Environmental Protection Agency and approved for publication. Any trade names or commercial products are examples only and are not endorsed or recommended by the U.S. Environmental Protection Agency.

For further information regarding this manual please contact:

Michael Forlini
Technology Innovation Office
U.S. Environmental Protection Agency
401 M Street, SW.
Washington, D.C. 20460

TABLE OF CONTENTS

Section	Title	Page
I.	INTRODUCTION TO THE SUPERFUND PROGRAM	I-1
II.	SUPERFUND LEGISLATIVE/REGULATORY FRAMEWORK	II-1
III.	SUPERFUND PROCESS	III-1
IV.	ENFORCEMENT PROGRAM	IV-1
V.	REMOVAL ACTIONS	V-1
VI.	SITE ASSESSMENT	VI-1
VII.	REMEDIAL ACTIONS	VII-1
VIII.	STATE AND INDIAN TRIBAL INVOLVEMENT	VIII-1
IX.	FEDERAL FACILITIES	IX-1
X.	COMMUNITY RELATIONS/PUBLIC PARTICIPATION	X-1
XI.	MANAGEMENT AND TECHNICAL INFRASTRUCTURE	XI-1
XII.	APPLICABLE OR RELEVANT AND APPROPRIATE REQUIREMENTS	XII-1
XIII.	CERCLA's RELATIONSHIP TO OTHER LEGISLATION	XIII-1
XIV.	FUTURE DIRECTIONS OF THE SUPERFUND PROGRAM	XIV-1
Appendix A:	Resource for Superfund Program Publications	A-1
Appendix B:	EPA Organizational Charts	B-1
Appendix C:	EPA Regional Office Directory	C-1
Appendix D:	CERCLA/Superfund Program Acronyms	D-1

LIST OF EXHIBITS

Number	Title	Page
1	The Superfund Process	III-2
2	The Basic Enforcement Process	IV-5
3	Removal Actions by Type of Incident	V-3
4	The Removal Process	V-10
5	The Site Assessment Process	VI-3
6	The Remedial Process	VII-3
7	RCRA and CERCLA: Different Approaches to a Common Goal	XIII-5
8	The Superfund Accelerated Cleanup Model (SACM) Process	XIV-4

SECTION I

INTRODUCTION TO THE SUPERFUND PROGRAM

C OVERVIEW

C WHY WAS SUPERFUND NECESSARY?

C WHAT MAKES SUPERFUND UNIQUE?

C WHAT IS HAZARDOUS SUBSTANCE?

- CERCLA Definition of a Hazardous substance, Pollutant, or Contaminant
- RCRA Definition of Hazardous Waste
- Other Hazardous Substances

C HOW DOES SUPERFUND WORK?

- Removal Actions
- Remedial Actions
- Enforcement Actions

C WHO IS INVOLVED IN SUPERFUND?

C WHERE IS THE SUPERFUND PROGRAM HEADED?

- *The 90-Day study*
- The Superfund Accelerated Cleanup Model

SECTION I INTRODUCTION TO THE SUPERFUND PROGRAM

OVERVIEW

The purpose of the Superfund program is to address threats to human health or the environment resulting from releases or potential releases of hazardous substances from abandoned or uncontrolled hazardous waste sites. The U.S. Environmental Protection Agency (EPA) has the primary responsibility for managing activities under the Superfund program.

The Superfund program is one of the nation's most ambitious and complex environmental programs. The number of actions taken and sites targeted by the Superfund program is substantial. For example more than 200 emergency actions must be taken each year to address immediate threats, and over 2,000 were taken in the first ten years of the program. More than 1,200 sites are currently scheduled for long-term cleanup and additional sites are being evaluated daily. While accomplishing its goals, the Superfund program must comply with a complex network of laws, regulations, and guidance. Superfund actions are further complicated by the necessary coordination with response officials at all levels of government, as well as the general public and the parties responsible for the threats. Finally, the response or cleanup technologies used at Superfund sites are constantly being challenged by the extraordinary variety of hazardous substance sites.

WHY WAS SUPERFUND NECESSARY?

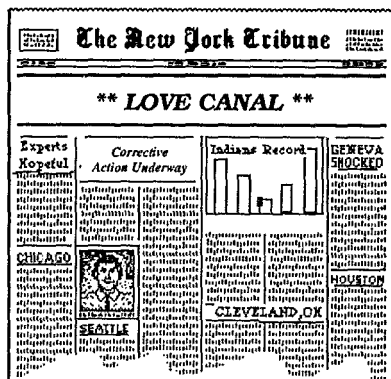

In the late 1970s, the threat of hazardous waste to human health and safety was brought to national public attention by the media coverage of several hazardous waste sites. The most controversial site was Love Canal in Niagara Falls, New York. Large amounts of abandoned, buried hazardous waste caused extensive contamination of the area, declaration of the area as a disaster by the Federal government, and eventual relocation of most area residents. Considerable publicity was also devoted to other sites such as the chemical control of the Livingston Train Derailment and the Valley of the Drums. Newspaper headlines frequently reported on transportation accidents, fires and explosions, buried drums, and other incidents at sites involving hazardous substance releases. These sites caused potential threats to soil, ground water, surface water, and air. However, there was no authority for direct Federal response to such hazards.

Several Federal environmental statutes did exist, however, the Federal Water Pollution Control Act, (FWPCA) and its amendment, the Clean Water Act of 1972 (CWA), focused on discharges of oil and hazardous substances into U.S. navigable waters, The Resource Conservation and Recovery Act of 1976 (RCRA) established a regulatory system to manage hazardous wastes from the time they are generated to their final disposal. RCRA also imposes standards for transporting, treating, storing, and disposing of hazardous wastes. It is designed to prevent the creation of new hazardous waste sites by authorizing EPA to take administrative, civil, and criminal actions against facility owners and operators who do not comply with RCRA requirements.

The discovery and subsequent publicity of hazardous waste sites such as Love Canal and Valley of the Drums made it acutely apparent that existing regulatory requirements were not enough. The Federal government sought to obtain the authority needed to deal with threats from hazardous substance sites to human health and the environment. The Comprehensive Environmental Response, Compensation, and Liability Act of 1980 (CERCLA) was designed to provide this authority.



CERCLA's passage in 1980 launched the Superfund program. This Act gave the Federal government, for the first time, authority to take direct action or force the responsible party to respond to emergencies involving uncontrolled releases of hazardous substances. The statute also required the Federal government to develop longer-term solutions for the nation's most serious hazardous waste problems. CERCLA gave authority to the President who, in turn, issued Executive Order 12316 delegating primary responsibility to EPA for managing activities under the Superfund program. The activities under the Superfund program include:

- Identifying sites where releases of hazardous substances had already occurred or might occur and pose a serious threat to human health, welfare, or the environment
- Taking appropriate action to remedy such releases
- Ensuring that parties responsible for the releases pay for the cleanup actions. This payment could be either the initial funding of cleanup actions or the repayment of Federal funds spent on response actions.

To pay for Federal response actions, CERCLA created a Trust Fund, or “Superfund,” of \$1.6 billion. This Trust Fund was financed primarily with a tax on crude oil and 42 commercially-used chemicals. The tax supports the concept that those responsible for environmental pollution should assume the cost. Thus, even though the Superfund program may finance the response action, recovery of these Federal funds is sought from those parties responsible for the hazardous release.

On October 17, 1986, Congress passed amendments to CERCLA, called the Superfund Amendments and Reauthorization Act (SARA). SARA made several important changes and additions to the Superfund Program that strengthened and expanded the cleanup program. SARA increased the size of the CERCLA Trust Fund to \$8.5 billion and refined its financing. SARA also stresses developing and using permanent remedies. In addition, SARA provides new enforcement authorities and settlement tools, requiring changes in the system used to determine which sites should be addressed and increasing State involvement in the Superfund process.

SARA included a free-standing statute, Title III. This statute increased community awareness and access to information regarding the presence of extremely hazardous chemicals in their community. Through the use of this information, communities are able to develop a local emergency response plan to help mitigate the effects of a chemical incident.

In November of 1990, Congress extended Superfund's statutory authority through 1994 and the taxing authority through 1995.

**WHAT MAKES SUPERFUND
UNIQUE?**

Prior to CERCLA, the Federal government lacked the authority and resources needed to respond to releases of hazardous substances (other than releases to surface water) or to clean up hazardous waste sites. As discussed above, earlier legislation provided primarily regulatory requirements, not authority to take emergency removal or longer-term remedial action. CERCLA's authority for Federal response enables EPA to address releases, or threatened releases, in the event responsible parties do not take timely, adequate action.

The Superfund program has several other distinct characteristics. Superfund is set apart from many other Federal environmental programs because it is uniquely action-oriented. It asserts that each potentially responsible party (PRP) associated with a site will be held liable, and places the cost burden on that party.

CERCLA is a strict liability statute, which means that responsible parties are liable without regard to negligence or fault. In situations where more than one PRP is involved, it may be difficult to determine each PRP's contribution to the release. In these situations, the courts have held that an owner, operator, waste generator or transporter may be held liable for the entire cost of site cleanup, unless it can be shown that the harm is "divisible" (e.g., there are two or more physically separate areas of contamination). This concept, known as, "joint and several liability", is a tool that encourages PRPs to perform cleanups.

Cost recovery of Trust Fund monies and PRP-financed actions are also unique characteristics of the Superfund program. EPA is authorized by CERCLA to take aggressive efforts to ensure that responsible parties assume as much of the cleanup costs as possible. Ideally, Trust Fund monies are used only when PRPs cannot be identified or are not financially viable. If they refuse to comply with a cleanup order under CERCLA, EPA may recover triple its costs from responsible parties. The Superfund program was also given broad and effective authorities to encourage responsible parties to reach voluntary settlements to pay for site, cleanups. Cost recovery efforts are critical to the success of the Superfund program because the cost of cleanup of all priority sites far exceeds the money available in the Trust Fund.

**WHAT IS A HAZARDOUS
SUBSTANCE?**

The Superfund program is triggered by a "release" or a "substantial threat of a release" of hazardous substances into the environment. A "release" is defined in CERCLA as any spilling, leaking, pumping, pouring, emitting, emptying discharging, injecting, escaping, leaching, dumping, or disposing of hazardous substances into the environment. The definition of a release includes the abandonment or discarding of barrels, containers, and other closed receptacles containing a hazardous substance, pollutant, or contaminant. The release must involve either:

- C A **hazardous substance**, as defined in the Superfund statute,
- or

- C A **pollutant or contaminant** that may present an imminent or substantial danger to public health or welfare.

CERCLA Definition of a Hazardous Substance, Pollutant,

"Hazardous substance" includes substances defined as "hazardous waste" under RCRA, as well as substances regulated under the Clean Air Act (CAA), Clean Water Act (CWA), and Toxic Substances Control Act (TSCA). In addition, any element, compound, mixture, solution, or substance may also be specifically designated as a "hazardous substance" under CERCLA. "Pollutant or contaminant" is defined in CERCLA as any element, substance, compound, or mixture that, after release into the environment and upon exposure, ingestion, inhalation, or assimilation into any organism, will or may reasonably be anticipated to cause illness, death, or deformation in any organism. Both definitions specifically exclude petroleum and natural gas, and thus CERCLA authority may not be used to respond to releases of these substances.

RCRA Definition of Hazardous Waste

"Hazardous waste" is defined under RCRA as a "solid waste, or combination of solid wastes, which because of its quantity, concentration, or physical, chemical, or infectious characteristics may:

1. Cause, or significantly contribute to an increase in mortality or an increase in serious irreversible, or incapacitating reversible illness, or
2. Pose a substantial present or potential hazard to human health or the environment when improperly treated, stored, transported, or disposed of, or otherwise managed."

RCRA defines hazardous waste in terms of properties of a solid waste. Therefore, if a waste is not a solid waste, it cannot be a hazardous waste. RCRA regulations define a solid waste as hazardous either by reference to a list of hazardous wastes or based on the waste's characteristics.

EPA has identified four characteristics for hazardous waste. Any solid waste that exhibits one or more of these characteristics is classified as hazardous waste under RCRA

and, in turn, as a hazardous substance under CERCLA. The four characteristics are ignitability, corrosivity, reactivity, and toxicity. The responsibility for determining if a particular solid waste is hazardous falls on the generator of the waste.

The vast majority of hazardous wastes are generated by chemical and petroleum industries. These industries alone generate 71 percent of all hazardous wastes. The remainder is generated by a wide range of other industries, including metal finishing, general manufacturing, and transportation.

Other Hazardous Substances

CERCLA's definition of "hazardous substance" also includes substances regulated by CWA, CAA, and TSCA:

- C The **CWA**, including amendments from the Oil Pollution Act of 1990 (OPA), regulates the discharge of pollutants, oil, or hazardous substances into U.S. navigable waters. EPA has designated more than 400 substances as either toxic chemicals or "hazardous substances" under the CWA.
- C The **CAA**, section 112, directs EPA to identify hazardous air pollutants (HAPs) and to establish emission standards, known as national emissions standards for hazardous air pollutants (NESHAPs), for sources that emit the pollutants. EPA has promulgated NESHAPs for sources of the following pollutants: arsenic, asbestos, benzene, beryllium, mercury, radionuclides, and vinyl chloride. Section 112 also defines almost 200 other substances as hazardous air pollutants.
- C **TSCA** provides authorities to control the manufacture, sale, and disposal of certain chemical substances, such as PCBs, CFCs, asbestos, and TCDD.

Substances defined by any of the above Acts as hazardous or toxic, are considered "hazardous substances" under CERCLA. However, CERCLA excludes petroleum unless it is specifically listed or designated under one of the above statutes.

HOW DOES SUPERFUND WORK?

EPA has the primary responsibility to manage the cleanup and enforcement activities under Superfund. A comprehensive regulation known as the National Oil and Hazardous Substances Pollution Contingency Plan (NCP) contains the guidelines and procedures for implementing the Superfund program. The Superfund process is depicted in Exhibit 1 on page III-2.

The first step in the Superfund process is to identify abandoned or uncontrolled hazardous waste sites. EPA does this through a variety of methods, including reviewing records and information on hazardous substance disposal and storage provided by States, handlers of hazardous materials, and concerned citizens. The NCP requires facility owners or operators to report releases exceeding the reportable quantity (RQ) of hazardous substances to the National Response Center. This center is continuously manned and acts as the single point of contact for all pollution incident reporting .

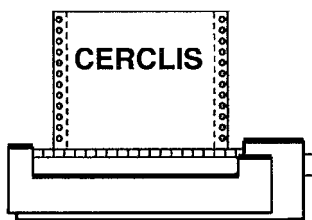

Once an abandoned or uncontrolled hazardous waste site is identified, information regarding the site is entered into a data base known as CERCLIS, the Comprehensive Environmental Response, Compensation, and Liability Information System. CERCLIS maintains a permanent record of all information regarding all reported potential hazardous waste sites.

After discovery or notification of a site or incident EPA or the State conducts a preliminary assessment (PA) to decide if the site poses a potential threat to human health and the environment. If the site presents a serious imminent threat, EPA may take an emergency "removal" action. If the PA shows that a contamination problem exists but does not pose an imminent threat, or if the site continues to pose a problem following EPA actions, EPA may proceed to the next step of the evaluation process, and conduct a site inspection (SI). If at any point during the assessment and inspection process the site is determined to not present a potential threat, the site can be eliminated from further CERCLA consideration with a decision that the site evaluation is accomplished (SEA).

From the beginning of the Superfund process, EPA makes every effort to identify the parties responsible for the hazard and encourage them to respond. If efforts to ensure responsible party response do not lead to prompt action, EPA may act using Trust Fund monies.

Every Superfund site is unique, and thus cleanups must be tailored to the specific needs of each site or hazardous substance release. EPA may respond with enforcement or Trust Fund- financed removal actions or remedial actions, collectively known as response actions.

Removal Actions

Removal actions are usually short-term actions designed to stabilize or cleanup a hazardous site that poses an immediate threat to human health or the environment. Also, removal actions are conducted in response to accidental releases of hazardous substances. Typical removal actions include removing tanks or drums of hazardous substance on the surface, installing security measures such as a fence at site, or providing a temporary alternate source of drinking water to local residents.

Remedial Actions

Remedial actions are generally longer-term and usually more costly actions aimed at a permanent remedy. EPA may use Trust Fund monies for remedial construction only at sites on the National Priorities List (NPL). The NPL is EPA's list of the nation's priority hazardous waste sites. Typical remedial actions may include removing buried drums from the site; thermally treating wastes; pumping and treating groundwater; and applying bioremediation techniques or other innovative technologies to contaminated soil.

Enforcement Actions

Enforcement actions to obtain voluntary settlement, or if necessary, to compel PRPs, may be taken to implement removal or remedial actions. Once the PRP has agreed to take response actions at a site, the enforcement program ensures that the studies or cleanup activities are performed correctly and in accordance with the order or decree, the statute, the NCP, and relevant guidance.

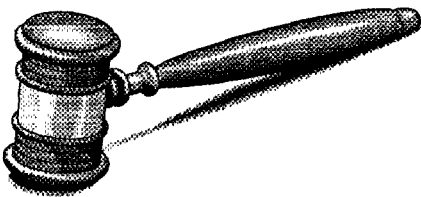

The PRPs may include the owners and operators, generators, transporters, and disposers of the hazardous substance. If sufficient evidence is present to show that PRPs are liable and the PRPs are financially viable (i.e., not bankrupt), they are generally given the opportunity to make a voluntary, good faith effort to settle and take responsive actions. Alternatively, EPA may issue orders directing them to conduct the response, or take court action to secure the necessary response.

CERCLA also authorizes the use of Trust Fund money for response actions and provides the authority necessary to seek repayment from responsible parties. EPA generally uses Trust Fund money to responsible if: (1) PRPs have not been identified or are not financially viable; (2) litigation against a PRP is pending; (3) insufficient evidence has been collected

linking a PRP to the waste; or (4) the threat is substantial and imminent enough to warrant immediate action. Where a PRP refuses to comply with an order, and EPA uses Trust Fund monies to perform the ordered work, EPA may recover triple the costs.

Criminal statutes also support CERCLA's enforcement tools. There are criminal penalties for failure to notify proper authorities of releases exceeding an RQ. Submitting false information about sites or releases are also criminal offenses.

WHO IS INVOLVED IN SUPERFUND?

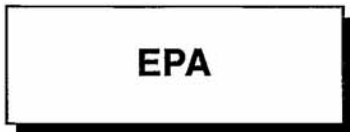

As stated above, EPA has the primary responsibility for managing the cleanup and enforcement activities under Superfund. The EPA officials with primary responsibility for directing response efforts and coordinating all activities at the scene of a discharge or release include **On-Scene Coordinators** (OSCs) and Remedial Project Managers (RPMs).

The OSC is the Federal official designated to coordinate and direct Superfund removal actions. The RPM is the official designated to manage remedial and /or other response actions at NPL sites. To ensure the effectiveness of response actions, both OSCs and RPMs are responsible for coordinating with EPA Regional staff (e.g., Regional Administrator, Office of Regional Counsel, etc.), EPA Headquarters staff, and other Federal, State, and local agencies.

In addition to OSCs and RPMs, EPA's Environmental Response Team (ERT) participates in the Superfund process. The ERT provides technical support to the Regional Superfund removal and remedial programs, and coordinates and conducts safety program activities. Major activities include on-site technical support, administrative support, information transfer, and safety program activities.

In addition to EPA, there are other major players in the Superfund process who have important roles in many cleanup activities. These participants include other Federal agencies, States and Indian Tribes, PRPs, and the communities in which the sites are located. Local governments are also involved because they are often the first on the scene in an emergency. It should be noted that Federal, State, and local agencies are not exempt from CERCLA, and therefore may be identified as PRPs.

**States and
Indian Tribes**

States have always been encouraged to participate in the Superfund process. Under current Superfund law, **Indian Tribes** are generally treated the same as States. Involvement of States has grown over time and they are now formally involved in virtually every phase of Superfund decision-making. CERCLA requires EPA to coordinate with States when the Federal government leads or oversees the site response. CERCLA also authorizes EPA to allow States and political subdivisions, such as county governments, with sufficient technical and management expertise, to act as the lead agency, and carry out most of the cleanup efforts. In these cases, EPA is still the Federal agency responsible for ensuring that the site cleaned up.

PRPs

The involvement and participation of **PRPs** is central to the Superfund program. This participation may result from a willingness on the part of the PRP to take the initiative to clean up their sites and from negotiations with EPA under which the company undertakes the work. However, private party participation may also be compelled by judicial action by EPA and the Department of Justice. In either case, PRPs follow the same process EPA follows; at each stage of the process PRP decision and construction of the remedy are subject to EPA's oversight and approval.

Community

EPA promotes two-way communication between the public, including PRPs, and the lead government agency in charge of response actions. The NCP provides interested persons about opportunity to comment on, and provide input to, decisions about response actions. The NCP ensures that the public is provided with accurate and timely information about response plans and progress, and that their concerns about planned actions are heard by the lead agency. Site-specific and well-planned community relations activities is an integral part of every Superfund response. Such activities include the following:

- C Publish a notice and brief analysis of the response action, describing proposed action
- C Give the public an opportunity to comment on the response action
- C provide an opportunity for a public meeting to permit two-way communication on the response action

- C Make a transcript of the public meeting available to the public as a part of the response action decision document
- C Prepare a response to each significant public comment on the proposed response action plan.

Public participation requirements may vary between the remedial process and removal actions, because of the urgency of removal actions.

WHERE IS THE SUPERFUND PROGRAM HEADED?



EPA's primary challenges, at the start of the Superfund program, were to respond to cleanup requests, build and staff an organizational structure, develop program policies and guidance, and develop technologies to clean up sites. In response to these challenges, EPA has developed and continues to streamline management procedures and policies to administer the Superfund program. In addition, the nation's scientific and engineering communities' efforts to solve the unique problems identified by Superfund have resulted in the development of a wide range of techniques for treating and disposing of hazardous substances, a greater understanding of the health effects, and an expansion of the nation's laboratory capacity.

The 90-Day Study

After more than ten years of experience implementing the Superfund program, EPA has had the opportunity to evaluate past program activities and achievements, and to identify enhancements needed. An EPA-published report, *Management Review of the Superfund Program* commonly called "*The 90-Day Study*," describes the achievements to date and a strategy for future management of the Superfund program. In this report, EPA announced a long-term strategy for Superfund. The strategy contains the following eight goals:

- C Control acute environmental threats immediately
- C Address worst sites/worst problems first
- C Monitor and maintain sites over the long-term
- C Emphasize enforcement
- C Develop and use new technologies
- C Improve efficiency of program operations
- C Encourage full public participation
- C Foster cooperation with other Federal and State agencies.

EPA developed these eight goals based on the lessons learned during the first ten years of the program, and will build upon those lessons to chart the course for the future.

*The Superfund Accelerated
Cleanup Model*

In early 1992, EPA initiated a plan aimed at streamlining the Superfund process and redefining the way progress is measured. The key objective of the plan is substantial, prioritized risk reduction in a shorter timeframe.

Under this new plan, called the **Superfund Accelerated Cleanup Model (SACM)**, EPA will integrate removal actions and remedial actions to address immediate and substantial risks, thus eliminating the procedural distinctions between the remedial and removal programs.

A goal of SACM is to streamline site assessments into one process and establish Regional Decision Teams to "traffic cop" sites for Early Actions, where appropriate. Early Actions are short-term, quickly implemented actions designed to eliminate significant risk from Superfund sites. These would generally be accomplished by time-critical removal actions, non-time-critical removal actions, or early action remedial actions. Long-term remedial actions would be used at sites requiring ground water restoration, mining sites, extended incineration projects, and wetlands /estuaries cleanups.

In general, the new approach would reduce the risks to human health quickly. The changes resulting from this new process (i.e., the risk reduction) would require a new way of counting achievements under Superfund. Also, this risk reduction will need to be communicated effectively to the general public.

The new Superfund model will be tested on a pilot basis in the Regions. SACM is discussed in greater detail in Section XIV: Future Directions of the Superfund Program.

SECTION II

SUPERFUND LEGISLATIVE AND REGULATORY FRAMEWORK

- **OVERVIEW**
- C** **COMPREHENSIVE ENVIRONMENTAL RESPONSE, COMPENSATION, AND LIABILITY ACT OF 1980 (CERCLA)**
- C** **SUPERFUND AMENDMENTS AND REAUTHORIZATION ACT OF 1986 (SARA)**
- C** **EMERGENCY PREPAREDNESS AND COMMUNITY RIGHT-TO-KNOW ACT OF 1986 (TITLE III)**
- C** **NATIONAL OIL AND HAZARDOUS SUBSTANCES POLLUTION CONTINGENCY PLAN (NCP)**

SECTION II SUPERFUND LEGISLATIVE AND REGULATORY FRAMEWORK

OVERVIEW

There are several laws and regulations that guide Superfund activity. The foundations of the Superfund program are the:

- Comprehensive Environmental Response, Compensation, and Liability Act of 1980 (CERCLA)
- Superfund Amendments and Reauthorization Act of 1986 (SARA)
- National Oil and Hazardous Substances Pollution Contingency Plan (NCP) (commonly known as the National Contingency Plan).

The Federal government's response to hazardous substance releases is built upon these foundations.

CERCLA

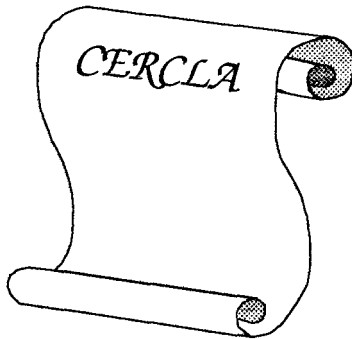

The superfund cleanup program was created by congress with the passage of the **Comprehensive Environmental Response, Compensation, and Liability Act of 1980 (CERCLA)**. CERCLA provided the first Federal response authority to address the problem of uncontrolled hazardous waste. In general, CERCLA was designed to:

- Give the Federal government the authority to take action to respond to release or threats of release of hazardous substances, pollutants, and contaminants
- Develop a comprehensive program to prioritize hazardous waste site nationwide
- Identify and compel potentially parties (PRPs) to conduct and/or pay for those cleanup wherever possible
- Set a \$1.6 billion Hazardous Substance Response Trust Fund—popularly known as "Superfund"—available to finance cleanups e.g., where PRPs cannot be found or are unable to pay for the response

- C Advance scientific and technological capabilities in all aspects of hazardous waste management, treatment, and disposal.

These objectives are intended to significantly improve hazardous waste management in the future.

The Superfund program was founded on the premise that the polluter must pay for problems created by the polluter. CERCLA was specifically designed to ensure that the cleanup responsibilities and costs are assumed by PRPs and that Trust Fund monies are generally spent when necessary. Trust Fund monies are generally spent for site cleanup if EPA cannot identify the responsible parties, or the PRPs are not successful. Federal agencies pay for cleanup of Federal hazardous wastes, such as military bases or weapons plants, out of their own budgets. They do not use Trust Fund monies.

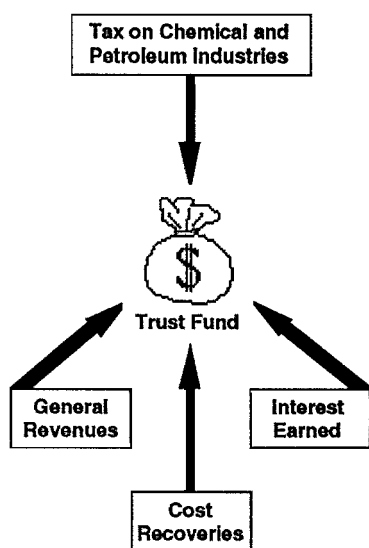

The monies in the Trust Fund are the result of several sources. First, CERCLA established a tax on the chemical and petroleum industries. Specifically, this tax is on crude oil and 42 different commercial chemicals. In addition to the tax, Trust Fund monies are also the result of general revenues, interest earned by the Trust Fund, and cost recoveries from PRPs.

During the first five years of the Superfund program, two facts became increasing clear: (1) the problem of uncontrolled hazardous substances sites was more extensive than originally though and (2) its solution would therefore be more complex and time-consuming. Progress in identifying hazardous substance site, investigating the sites' threats to human health and the environment, and cleaning up the worst sites was slow in the early years.

CERCLA was due to be reauthorized in 1985, but delays in reauthorization severely curtailed Superfund's activities in late 1985 and 1986. Almost all non-emergency work ceased as taxing authority ran out and remaining funds were carefully rationed.

SARA

On October 17, 1986, the Superfund program was reauthorized by the **Superfund Amendments and Reauthorization Act of 1986 (SARA)**. SARA reflected EPA'S

experience in administering the complex Superfund program during its first six years. The reauthorized law made several important changes and additions to the program. One of the major features of SARA was that the new Trust Fund was \$8.5 billion. This is more than five times the amount of money previously in the Trust Fund.

SARA introduced many other improvements to the Superfund program. These improvements had an impact on nearly every major action and authority under Superfund. SARA improved the power of:

Removal Actions

- The limits on removal actions financed by the Trust Fund were raised from six months/\$1 million, financed by the Trust Fund, to one year/\$2 million (although these limits may be exceeded if an exception is justified).
- All removal actions were required to be consistent with any long-term remedial action.

Remedial Actions

- New cleanup goals and schedules were established. Goals were set for the completion of preliminary assessments of sites on EPA's inventory of potentially hazardous sites.
- Mandatory deadlines were set for the completion of critical phases of remedial work at priority sites.
- A preference was established for remedies that reduce the toxicity mobility, or volume of waste through treatment as a primary element.
- EPA was ordered to select remedies that are cost-effective, and utilize permanent solutions to the maximum extent practicable.
- The statute established off-site land disposal without treatment as the least-preferred alternative.

Enforcement Authorities

- The use of settlement tools was encouraged to obtain agreements with PRPs to pay for and/or conduct the

cleanup. During the first years of Superfund, EPA realized that settlements were the most cost-effective way of preserving Trust Fund resources. Lengthy litigation was too resource intensive.

- Increased criminal penalties were authorized for failure to report releases of hazardous substances. SARA also made it a criminal offense to provide false or misleading information regarding releases.
- EPA's access to hazardous substance sites for the completion of investigations and cleanups was improved.

State Involvement

- EPA was required to coordinate with the State during all phases of a response.

Public Participation

- Requirements were established that ensure public participation and notification during the formulation of plans for Superfund actions.
- Technical assistance grants were authorized so citizens could hire experts to explain the complexities of hazardous substance problems and the Superfund program at NPL sites.
- Information repositories and Administrative Records documenting site information and response activity decisions were required for each site and must be made accessible to the public.

Research, Development, and Training

- A comprehensive, coordinated research and development program was initiated. This program included technology demonstration programs that offer alternatives to conventional hazardous substance treatment or site cleanups.
- Research and training programs for hazardous substance response were expanded.

In addition to the above improvements, SARA included an important section that focused on strengthening the rights of citizens and communities in the face of potential hazardous substance emergencies. This section is commonly called “SARA Title III.”

TITLE III

SARA Title III, the Emergency Planning and Community Right-to-Know Act of 1986 (EPCRA), was designed to help communities prepare to respond in the event of a chemical emergency, and to increase the public’s knowledge of the presence and threat of hazardous chemicals. SARA Title III established a four-part program to:

1. Define emergency planning structures at the State/local level and develop local emergency response plans
2. Require emergency notification of chemical releases
3. Require notification of chemical use, storage, and production activities
4. Report annual emissions requirements.

The organizations responsible for the State/local planning include State Emergency Response Commissions (SERCs) and Local Emergency Planning Committees (LEPCs).

Under SARA Title III, facilities must compile information about extremely hazardous substances they have on site and the threat posed by those substances. In addition, those facilities must report any accidental releases of extremely hazardous substances. This information must be provided to State and local authorities, and more specific data must be made available upon request from those authorities or from the general public.

Under the Community Right-to-Know provisions of SARA Title III, facilities must report to the SERC, LEPC, and fire department all extremely hazardous substances at their facility above a certain amount. In addition, manufacturing facilities must report any routine releases of toxic chemicals to EPA and the State.

It should be noted that, strictly speaking, SARA Title III is a separate statute from CERCLA.

Throughout this manual, specific and relevant sections of CERCLA are referenced and applied to the different programs or actions. Henceforth, when CERCLA is cited, it is CERCLA as amended by SARA.

NCP

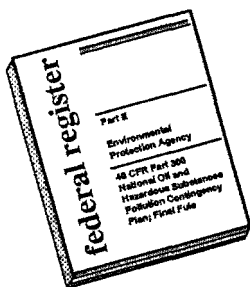

The Superfund response effort is guided by the **National Oil and Hazardous Substances Pollution Contingency Plan**, commonly referred to as the **National Contingency Plan (NCP)**. The NCP is the regulation that implements CERCLA. Revised on March 8, 1990 (55 FR 8666-8865), it outlines EPA's national program for response to releases of hazardous substances. The NCP outlines a step-by-step process for conducting both removal and remedial actions. In addition, the NCP defines the roles and responsibilities of EPA, other Federal agencies, the States, private parties, and communities in response to situations in which hazardous substances or oil are released into the environment.

The National Response Team (NRT), made up of representatives from fourteen Federal agencies, is responsible for planning and coordinating preparedness and emergency response actions. Regional Response Teams (RRTs), made up of designated representatives from each Federal agency and State government, are responsible for regional planning and preparedness activities before Superfund emergency response actions.

The NCP, which actually predates Superfund, was originally written to implement provisions in the Clean Water Act having to do with spills of oil and hazardous substances into navigable waters. It has been revised three times: first to incorporate the 1980 Superfund program; then in 1985 to streamline the Superfund process; and most recently in March of 1990 to address significant changes in the Superfund program resulting from the enactment of SARA.

The NCP reiterates EPA's goal of selecting remedies that protect human health and the environment, that maintain protection over time, and that minimize untreated waste. EPA believes that treating waste and rendering it nonhazardous (rather than containing it) is generally the preferred method for achieving long-term protection. The NCP promotes use of innovative technologies in order to bolster development of new methods to ensure long-term protection.

The NCP describes the procedures for conducting Superfund removal actions in response to a release or threatened release of a hazardous substance which may present an imminent and substantial danger. The NCP criteria for selecting a removal action are actual or threat of exposure from a release, contamination of drinking wells or ecosystems, and threat of fire or explosion. If a removal action is warranted, EPA evaluates the situation and selects a response. This remedy is documented in an Action Memorandum. If the urgency of the situation allows, the public will have an opportunity to comment on the removal action prior to the action.

The NCP sets forth nine criteria for selecting Superfund remedial actions. The two most important are considered to be the following *threshold criteria*:

- Overall protection of human health and the environment
- Compliance with (or waiver of) requirements of other Federal and State environmental laws

Each remedy that is selected at a Superfund site must meet the two threshold criteria.

Potential remedial actions are also evaluated according to the five *primary balancing* criteria: Long-term effectiveness and permanence; toxicity, mobility, or volume of waste; short-term effectiveness; implementability; and cost. The last two criteria are the *modifying criteria* of State acceptance and community acceptance.

EPA selects its preferred alternative, and releases to the public a proposed plan documenting why EPA believes that the preferred alternative is capable of remediating the site. The public must then have ample opportunity to comment on all preferred remedies and EPA must consider those comments in selecting the final remedy. EPA documents the selected remedy in the Record of Decision (ROD).

Congress expanded the role of communities in SARA. Consistent with this, the NCP requires EPA to consult with the public throughout cleanup. EPA must interview community groups at the start of a cleanup study to identify their concerns and must prepare a Community Relations Plan

that addresses those concerns. The public must have ample opportunity to comment on all proposed remedies and EPA must consider those comments in selecting the final remedy.

The NCP also reinforces the enforcement authority of EPA and details procedures for documenting EPA costs and compiling an administrative record documenting the selection of a response action.

The NCP defines a major role for States in all cleanup actions. Under the NCP, qualified States may act as lead agency for many cleanup actions under a cost-sharing agreement with EPA. Even when States support rather than lead the cleanup, they have a crucial role in identifying cleanup standards and commenting on proposed remedies.

The actual process established by the NCP for handling hazardous substance problems is discussed further in Section III: The Superfund Process.

SECTION III
THE SUPERFUND PROCESS

- **OVERVIEW**
 - S Continuous Enforcement Efforts /Public Participation
- **SITE DISCOVERY**
- **PRELIMINARY ASSESSMENT / SITE INSPECTION**
- **REMOVAL ACTIONS**
- **HAZARD RANKING SYSTEM / NATIONAL PRIORITIES LIST**
- **REMEDIAL INVESTIGATION / FEASIBILITY STUDY**
- **RECORD OF DECISION - REMEDY SELECTION**
- **REMEDIAL DESIGN / REMEDIAL ACTION**
- **SITE COMPLETION/OPERATION AND MAINTENANCE**
- **CLOSEOUT / NPL DELETION**

SECTION III THE SUPERFUND PROCESS

OVERVIEW

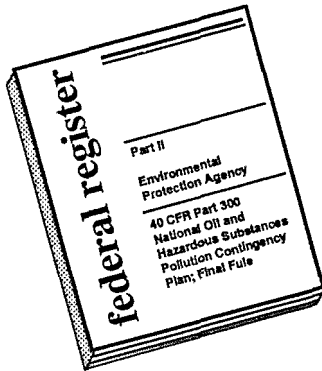

As discussed in Section II, the Superfund response process is guided by the **National Oil and Hazardous Substances Pollution Contingency Plan (NCP)**. This plan outlines several steps that EPA and other agencies must follow in responding to hazardous substance releases

In brief, the process established by the NCP for handling hazardous substance releases is as follows:

- Identify places where a hazardous substance problem may exist
- Do a preliminary evaluation to assess the degree of contamination
- If the preliminary evaluation reveals there is an emergency requiring immediate action, take the immediate “removal” action to remove or stabilize the threat
- If the preliminary evaluation reveals longer-term action may be required to respond to the contamination, begin “remedial” action evaluation process
- If the evaluation process indicates that longer-term action may be necessary to respond to the contamination, then conduct an analysis of the specifics of the contamination (e.g., affected populations) and select, design, and construct the remedy.

The critical steps in a Superfund response are illustrated in Exhibit 1. Each separate step has a different set of key players, and is essential to the ultimate goal of minimizing or eliminating the threat of a hazardous substance release. This section provides a general discussion of the major steps in the Superfund process. Later sections of the manual discuss these steps in greater detail (e.g., Removal Actions, Remedial Actions).

Continuous Enforcement Efforts/ Public Participation

At most stages of response, work can be done by a State or EPA using the Trust Fund, or by potentially responsible parties (PRPs) as a discovered, PRPs are sought and if found, negotiations result of **enforcement efforts**. As soon as a site is discovered, PRPs are sought and if found, negotiations

Exhibit 1 The Superfund Process

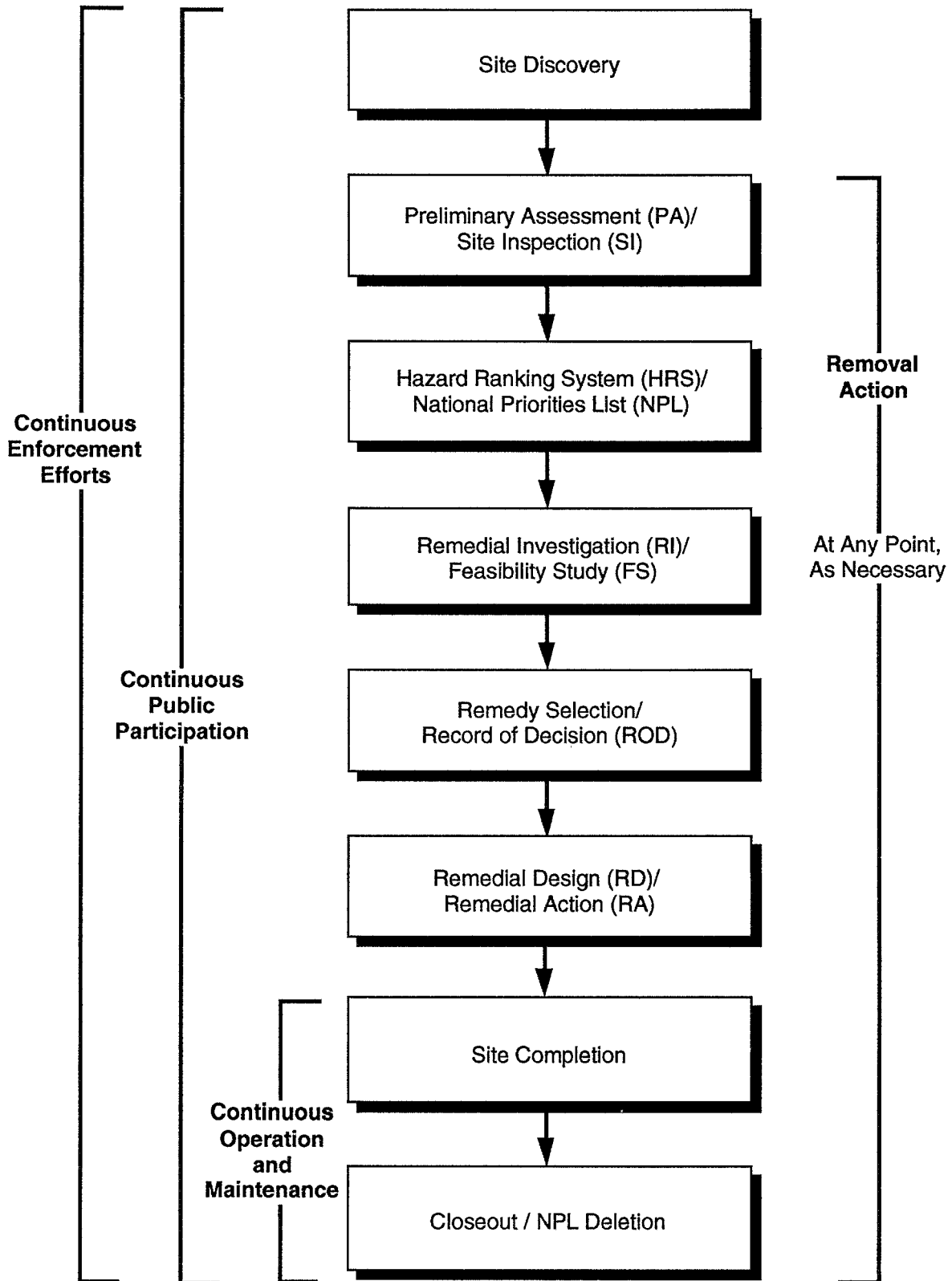

may begin to have the PRPs pay for and/or conduct the necessary response action. Also, community relations activities take place throughout the cleanup process to ensure **public participation** in the decision-making process.

SITE DISCOVERY

In the early days of CERCLA, EPA anticipated the entire scope of hazardous substance problems to be much smaller than we know it to be today. Few realized the size of the problem until EPA began the process of site discovery and site evaluation. Not hundreds, but thousands of potentially hazardous waste sites were discovered.

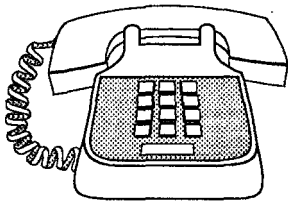

EPA continues its effort to identify potentially hazardous sites/ releases that might otherwise go unreported. Many site discoveries result from information and reports from States, communities, local authorities, businesses, and citizens. The National Response Center has set up a 24-hour hotline to receive information regarding potentially hazardous substance releases.

All reports of potential sites are entered into the Superfund site inventory, a computerized data base called "CERCLIS" (Comprehensive Environmental Response, Compensation, and Liability Information System).

PRELIMINARY ASSESSMENT/ SITE INSPECTION

Once a site is identified, EPA or the State conducts a site assessment, beginning with a **preliminary assessment (PA)** to determine if the site poses a potential hazard and whether further action is necessary. During this preliminary assessment, officials begin by reviewing any available documents about the site. In addition, there maybe a site visit, but sampling generally does not occur at this time. If the PA reveals that the site does not present a potential hazard, the site is designated as Site Evaluation Accomplished (SEA) and considered completed.

If the PA reveals a contamination problem exists but does not pose an immediate threat, EPA will perform a more extensive study called the **site inspection (SI)**. Typically, the SI involves a site visit and sample collection to define and further characterize the site's problems. If the site presents an imminent threat, EPA may use Trust Fund monies to effect immediate removal action.

Often in conjunction with the site inspection, EPA makes every effort to search for and identify PRPs. As discussed earlier, one of the central premises of CERCLA is the notion that the responsible party must pay. From the very start, EPA uses its authority under CERCLA to settle with or compel PRPs to pay for and/or conduct necessary response actions.

REMOVAL ACTIONS

A **removal action** is a short-term action intended to stabilize or clean up an incident or site which poses an imminent threat to human health or the environment. Removal actions may be conducted, for example, to clean up the spill of hazardous materials when a truck or train overturns, to keep the public from being exposed to hazardous substances, or to protect a drinking water supply from contamination. Typical removal actions include removing tanks or drums of hazardous substances on the surface, installing fencing or other security measures, and providing an alternate source of drinking water to local residents. In the event of longer-term cleanup requirements, the site is referred to the remedial program for further investigation and assessment.

Because removal actions are generally intended to reduce or eliminate imminent threats from contamination and are short-term actions, environmental problems such as area-wide contamination of ground water are not normally addressed. However, removal actions may reduce the cost of longer-term cleanup by controlling the migration of the hazardous substance or by eliminating the source of the additional contamination. Therefore removal actions may occur at NPL and non-NPL sites.

Removal actions are discussed in greater detail in Section V: Removal Actions.

HAZARD RANKING SYSTEM/ NATIONAL PRIORITIES LIST

Based on information obtained from the site inspection, EPA uses the **Hazard Ranking System (HRS)** to evaluate the potential relative risks to public health and the environment. The HRS is a numerically-based, scoring system that uses information from the PA and SI to assign each site a score ranging from 0 to 100. This score is based on:

- The likelihood that a site has released, or has the potential to release, contaminants into the environment
- The characteristics of the substance(s), i.e., toxicity and quantity

- The people or sensitive environments affected by the release.

The HRS score is used as a screening mechanism to determine whether the site should be considered for further action under CERCLA. It does not determine if cleanup is possible or worthwhile, nor the amount of cleanup needed.

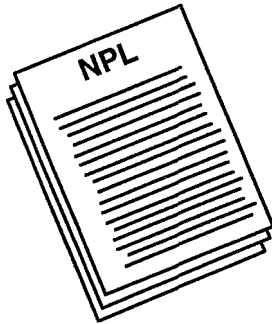

Sites with HRS scores of 28.50 or higher are considered for placement on EPA's **National Priorities List (NPL)**. Sites on the NPL represent the priority hazardous substance sites, nationwide. These sites are eligible for long-term remedial actions financed through the Superfund program.

Congress required EPA to create the NPL to identify the most serious sites, focus its efforts on those sites, and take into account the many other sites in need of attention when deciding how much Trust Fund money to spend on a particular site. This ensured that Superfund monies were spent on the most serious problems, and avoided exhausting the Trust Fund on an individual site. The purpose of the NPL is to notify the public of sites that EPA decides *may* represent a long-term threat to public health or the environment and may need remedial action. Only sites on the NPL are eligible for long-term remedial response using Trust Fund money. However, removal actions and enforcement actions may be taken at both NPL and non-NPL sites if there is a threat to public health or the environment.

The entire site assessment process, and its components, are discussed in greater detail in Section VI: Site Assessment.

Remedial Responses

Two main phases:

- RI/FS
- RD/RA

Remedial responses are generally longer-term actions that eliminate or substantially reduce releases, or threatened releases, of hazardous substances that pose a threat to human health and the environment, but that are not immediately threatening. Trust Fund-financed remedial responses are undertaken only at sites on the NPL.

Remedial responses have two main phases: the remedial investigation and feasibility study (RI/FS), and the remedial design/remedial action (RD/RA). During the RI/FS, conditions at the site are studied, the problem(s) are identified, and alternative methods to clean up the site are evaluated. The RI/FS is an interactive process that may take two years or more to complete.

**REMEDIAL INVESTIGATION/
FEASIBILITY STUDY**

During a **remedial investigation (RI)**, EPA, the State, or the PRP (with EPA or State oversight) collects and analyzes information to determine the nature and extent of contamination at the site. As information on the extent of contamination becomes known, the feasibility study is begun.

During the **feasibility study (FS)**, specific alternative remedies are considered and evaluated by EPA and the public. These may include removal of hazardous substances from the site and moving them to an EPA- or State-approved, licensed hazardous waste facility for treatment, containment, or destruction, safely containing the waste on-site, or destroying or treating the waste on-site through incineration or other treatment technologies.

**RECORD OF DECISION -
REMEDY SELECTION**

Generally, a preferred remedy is ultimately identified from the list of alternative remedies evaluated during the RI/ FS. This preferred remedy is presented to the public, for comment, in a Proposed Plan. Once comments have been received and evaluated, a final remedy is selected and documented in a Record of Decision (ROD).

**REMEDIAL DESIGN/
REMEDIAL ACTION**

In the **remedial design and action** stage, the recommended cleanup is designed, then undertaken. The design phase can take up to one year, and, in some cases, even longer. The time required to complete the remedy varies according to the complexity of the remedy.

As discussed earlier, EPA often conducts both removal and remedial actions at NPL sites. Removal actions may be required during a remedial action if an immediate threat is discovered during the course of the remedial work.

**SITE COMPLETION/
OPERATION AND
MAINTENANCE**

Following remedial actions, steps must be followed to ensure that the cleanup methods are working properly. Once the remedy implemented is operational and functional and meets its designated environmental, technical, legal and institutional requirements, it will be considered a **site completion**. Once the remedial actions are completed continuing site **operation and maintenance (O&M)** activities are conducted to maintain the effectiveness of the remedy and to ensure that no new threat to human health or the environment arises. The responsibility for O&M activities, if any, are ultimately assumed by the States or the PRPs.

However, EPA is responsible for actively reviewing O&M activity and schedule throughout the life of the remedy.

CLOSEOUT / NPL DELETION

Once a response action has been completed, the site often must be monitored, maintained, and ultimately closed out.

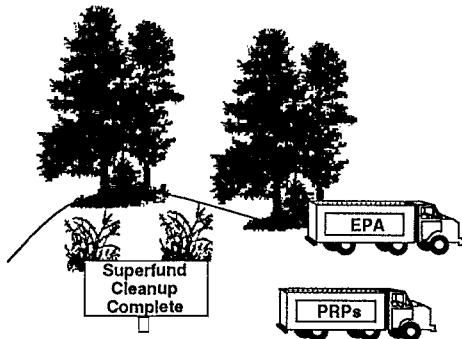

Following removal actions, several things must be done to prepare for **site closeout**. When planning for a site closeout, EPA must ensure that all waste is properly disposed, that all equipment is decontaminated and demobilized, that temporarily relocated citizens are returned to their homes, and that response-related damages are remedied, i.e., site is restored. The actual completion date of a removal is defined as the date when all previously specified work is completed and the contractor, PRPs, and EPA representatives have permanently demobilized.

For remedial responses, once a site is certified to be complete, EPA submits its intention to **delete** the site from the NPL by publishing a notice in the Federal Register. However, it should be noted that EPA cannot certify site completion and consider NPL deletion if the hazardous substance is still located on-site, e.g., a containment remedy was used. If the hazardous substance remains on-site, a five-year review of the site must be conducted before the site can be considered for NPL deletion.

As a part of site closeout, a closeout report is prepared to document that the State or PRP will ensure O&M activities are performed, and that EPA has completed its responsibilities.

SECTION IV

ENFORCEMENT PROGRAM

! OVERVIEW

! GOALS OF THE ENFORCEMENT

! STATUTORY FRAMEWORK

- CERCLA Enforcement Authority
- Other Statutory Enforcement Authority

! THE ENFORCEMENT PROCESS

- PRP Search and Identification
- Negotiations
- Settlements and Settlement Tools
- Oversight of PRP Work
- Cost Recovery

! KEY PLAYERS IN THE ENFORCEMENT PROGRAM

- EPA
- Other Federal Agencies
- States
- Natural Resources Trustees

SECTION IV ENFORCEMENT PROGRAM

OVERVIEW

The basic principle of the Superfund enforcement program is to make the responsible party pay for the response activities needed to clean up sites. When Congress passed CERCLA in 1980, it set as a guiding policy the principle that those responsible for the hazardous substances at a site should bear the burden of the cleanup. Consistent with this principle, Congress enacted strong enforcement provisions. These provisions were enhanced in 1986 with the passage of the Superfund Amendments and Reauthorization Act (SARA).

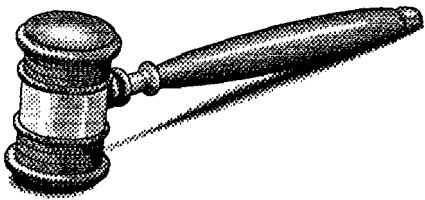

CERCLA section 101(25) defines response activities to include three different types of actions: removal, remedial, and enforcement. Although enforcement activities are not cleanup activities, they are included in the definition of response actions under Superfund. Enforcement includes the activities EPA undertakes to encourage or, if necessary, compel a potentially responsible party (PRP) to clean up a site or to recover costs of cleanup from potentially responsible parties.

The enforcement program relies heavily upon the statutory authority provided by CERCLA, particularly sections 104, 106, 107, and 122. These CERCLA sections are discussed in greater detail later in this section.

GOALS OF THE ENFORCEMENT PROGRAM

The two principal goals of the enforcement program are to:

- **Obtain cleanups from PRPs** through voluntary settlement, unilateral orders, or litigation
- **Oversee PRP-conducted cleanups** to ensure that remedies are protective of public health and environment and implemented in compliance with the terms of the settlement agreement.

As a part of this oversight, the enforcement program ensures that the studies or cleanup activities are performed correctly and in accordance with the order or decree, the statute, the National Oil and Hazardous Substances Pollution Contingency Plan (NCP), and relevant guidance.

If PRP response is not voluntarily obtained or is not adequate, EPA can either issue an order to compel the PRP to conduct the cleanup, or conduct the necessary cleanup itself and fund the cleanup with Federal Trust Fund monies. In the latter situations where EPA has performed removal or remedial activities at the site or incurred any enforcement costs, the enforcement program's goal is to recover those costs from the PRPs. Cost recovery actions are essential both to replenish the Trust Fund and to deter other PRPs from trying to avoid responsibility for performing response actions themselves.

The goals of the enforcement program apply to both remedial and removal responses. The process is similar for both responses, but many of the steps are abbreviated for removals.

STATUTORY FRAMEWORK

CERCLA provides EPA with a strong foundation for obtaining PRP cooperation in cleaning up contaminated sites. The enforcement authorities provided by CERCLA are outlined below. In addition, other laws that provide further enforcement authorities are discussed.

CERCLA Enforcement Authority

CERCLA Enforcement Authority
<ul style="list-style-type: none">• Section 104• Section 106• Section 107• Section 122

CERCLA, as amended by SARA, provides EPA with the authority and necessary tools to respond directly or to compel PRPs to respond to releases or threatened releases of hazardous substances. Also, CERCLA includes criminal penalties, authorizes EPA to issue unilateral administrative orders, and provides for settlement agreements. The sections of CERCLA that provide EPA with enforcement authority include sections 104, 106, 107, and 122.

Section 104(e) of CERCLA gives EPA the authority to issue information requests. The purposes of these information requests include:

- Gather information and evidence of PRP liability
- Gather information on financial viability of PRPs
- Identify resistant PRPs early in the enforcement process.

EPA also can use the authority under section 104(e) to obtain site access.

Section 106 of CERCLA includes authority for EPA to unilaterally order PRPs to implement site cleanups when there is imminent and substantial endangerment presented by the site.

Section 107(a) of CERCLA establishes authority for the recovery of all response action costs and recovery of all damages to natural resources. Section 107(e)(s) provides for the recovery of up to three times EPA's response costs, if PRPs have failed to comply satisfactorily with a section 106 unilateral administrative order. EPA may recover costs through a number of actions, including demand letters, negotiations with PRPs, arbitration, administrative settlement, judicial settlement, and litigation.

Section 122 of CERCLA provides settlement "tools" that may be used to encourage PRPs to negotiate a settlement for site cleanup. It is EPA's policy to allow the PRP to conduct the response when the PRP:

- Can demonstrate it is technically qualified /capable of performing necessary activities in a timely manner
- Agrees to conduct the response in accordance with the terms of the administrative order or consent decree
- Reimburses the Trust Fund for oversight costs incurred by EPA.

Section 122 authorizes EPA to enter into agreements with PRPs that allow the PRPs to conduct all or part of the response activities.

Other Statutory Enforcement Authority

In addition to the authorities provided by CERCLA, EPA may use authorities provided by other environmental laws. For example, under the Resource Conservation and Recovery Act (RCRA), EPA can order owners and operators of operating hazardous waste facilities and hazardous waste facilities in the process of closing to investigate any potential leaks and to clean up the facility if necessary. The Toxic Substances Control Act (TSCA) and its regulations can be used by EPA to impose conditions on the handling of particularly hazardous substances, such as asbestos and PCBs. In addition, in some cases where releases affect surface waters, the provisions of the Clean Water Act (CWA), including amendments from the Oil Pollution Act (OPA), can be used to impose fines and require cleanup.

THE ENFORCEMENT PROCESS

The overall Superfund program involves an integrated process of both enforcement and Trust Fund-financed activities aimed at achieving the overall goal of site cleanup. In general, EPA:

- Searches for and identifies PRPs who maybe liable for site response
- Attempts to negotiate agreements with the PRPs to perform studies or cleanup
- Enters into settlements with the PRPs where possible
- Oversees the site work that the PRPs perform under the settlement.

These steps are discussed below in greater detail.

If the PRPs do not settle, EPA may do one or more of the following:

- Issue an administrative order to compel the PRPs to perform the cleanup
- Sue the PRPs to implement an administrative order, or seek treble damages in a cost recovery action
- Conduct the cleanup, using Trust Fund monies, and later pursue cost recovery from the PRPs.

The basic enforcement process is illustrated in Exhibit 2.

Section 107(a) of CERCLA identifies four classes of PRPs:

- Current facility owners and/or operators
- Past facility owners and operators at the time of disposal of a hazardous substance
- Person(s) who arranged for treatment or disposal of hazardous substances (e.g., generators)
- Transporters of hazardous substances who selected the disposal site.

**Exhibit 2
The Basic Enforcement Process**

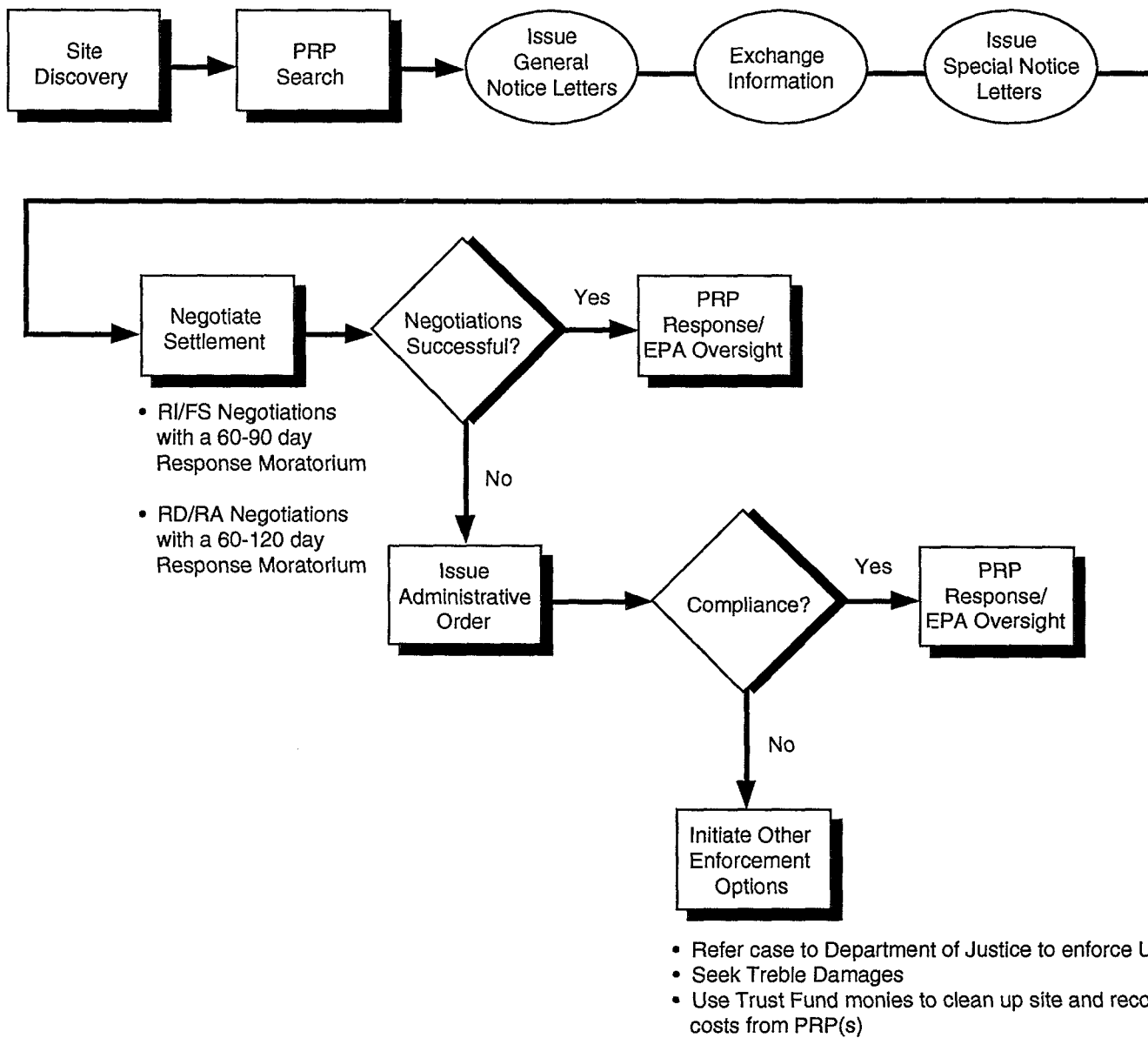

CERCLA imposes joint and several liability for all response costs incurred at the site, that are not inconsistent with the NCP, if a person falls within one of these four classes.

PRP Search and Identification



EPA attempts to identify any parties that may be liable for the release or threat of release of a hazardous substance at a site as early as possible, ideally before a site is proposed for listing on the NPL. This identification process is known as a **PRP search**. The search seeks to identify the generators, transporters, owners, and/or operators of a site. This may involve detailed title searches, employee interviews, documentation reviews, interviews with site operators and transporters, interviews with neighboring industries, site visits to document obvious evidence (e.g., labels on the barrels on site), etc. In addition, EPA generally sends out section 104(e) information request letters to those whom EPA thinks may have knowledge of operations at the site.

PRPs that are identified by this process are notified of their potential liability via a general notice letter, and are informed that they will have the opportunity to negotiate with EPA to conduct site cleanup. Either before or with this notification, EPA also may include an information request to determine the extent of PRP liability.

If a party is identified as a PRP, CERCLA imposes *strict liability* for all response costs incurred at the site that are not inconsistent with the NCP. This means that legal responsibility is imposed without regard to fault, and diligence generally is no defense. When more than one PRP is involved at a site and the harm is indivisible (such as in the case of intermingled drums, commingled wastes and contaminated soil or ground water), the court may impose *joint and several liability* upon all parties involved at the site. If joint and several liability is imposed on the PRPs, each PRP involved at the site is individually liable for the cost of the entire response action. However, EPA's practice is to attempt to identify and notify the universe of PRPs and to issue orders and litigate against the largest manageable number of parties.

A PRP's liability is subject to the very limited defenses listed in CERCLA section 107(b). A PRP can avoid liability only by proving that the release or threatened release was caused solely by: (1) an act of God; or (2) an act of war; or, (3) in certain narrow circumstances, a third party who was not a

PRP employee and who did not have a contractual relationship with the PRP. In cases where the PRP raises the defense that the release was caused solely by a third party, the PRP will be excused from liability only if the PRP can prove that he/she exercised due care and took precautions against foreseeable acts or omissions of these third parties. Also, under section 101 (35) (A) of CERCLA, a person who acquired property after the hazardous substance was disposed or placed on the facility may raise the innocent landowner defense. To assert this defense, the defendant must prove that he/she acquired the property without knowing, or having reason to know, that hazardous substances were disposed of in, on, or at the property. To establish that he/she had no reason to know of such disposal, the PRP must have undertaken all appropriate inquiry at the time of acquisition. A private party may also avoid liability by establishing that he/she is a subsequent owner of the land who acquired the site through bequest or inheritance, and that the party exercised due care and took precautions against the foreseeable acts and omissions of the third party.

Negotiations

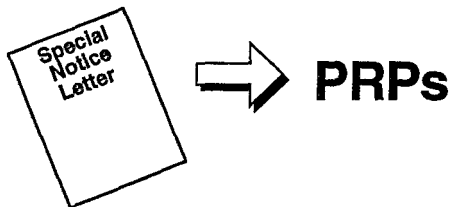

When there is sufficient information to identify PRPs, EPA normally issues a general notice letter to each PRP notifying them of their potential liability. As soon as PRPs are identified, EPA begins exchanging information with them concerning site conditions and other PRPs involved at the site.

Based on information obtained during the PRP search and information exchange process, EPA also may issue special notice letters to PRPs. The special notice letter begins a formal negotiation period and establishes a moratorium of 60 days on certain response and enforcement activities. During the negotiation period, EPA and the PRPs try to reach an agreement wherein the PRPs finance and conduct the work. If within 60 days, PRPs make a "good-faith offer" to conduct the response action, the moratorium may be extended to provide additional time for reaching a final settlement. For remedial investigation/feasibility study (RI/FS) negotiations, the moratorium may be extended an additional 30 days; for remedial design/remedial action (RD/RA) negotiations, it may be extended an additional 60 days.

In general, the purpose of these negotiations is to reach agreement that the PRPs will perform the RI/FS or the RD/RA and pay past costs and oversight costs incurred by EPA.

A settlement agreement may be signed if EPA is confident in the PRPs capabilities to conduct the response activities. With most agreements, EPA is responsible for overseeing the work of PRPs.

If no agreement is reached with the PRPs, EPA can either:

- C Issue a unilateral administrative order to force liable, financially viable PRPs to conduct the response action (this occurs very infrequently for RI/FS activities), or
- C Use Trust Fund monies to perform the work and later seek to recover response costs incurred.

Generally, EPA will do the work at a site only when a settlement cannot be reached or when the PRPs fail to comply with an administrative or judicial order.

Settlements and Settlement Tools

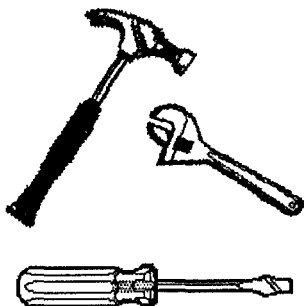

If negotiations are successful, EPA and the PRPs sign a legal document that sets forth the requirements for study or cleanup. The type of settlement agreement differs with the type of work required at the site. There are two general types of settlement agreements, administrative and judicial. **Administrative settlements** are authorized by CERCLA, initiated by EPA, and not required to go through court approval. Even though they do not require initial court approval, administrative settlements are judicially enforceable. **Judicial settlements** are filed by DOJ on behalf of EPA in court.

More specifically, the administrative and judicial documents that finalize settlements include the following:

- **Administrative Orders on Consent (AOCs)** — AOCs are binding agreements between EPA and PRPs. AOCs, to become effective, require the PRP's and Regional Administrator's signature. Removals and RI/FS negotiations are usually resolved with AOCs.
- **Consent Decrees (CDs)** — A CD is similar to an AOC, except that it is a judicial action which must be filed in court, published in the Federal Register for public comment, and approved by a judge before it becomes final. Like

AOCs, CDs provide information on the site's background, name the parties bound by the decree, describe the roles and responsibilities of the bound parties, and set forth performance standards that the remedy must meet and stipulated penalties for not complying with those standards. CDs also detail financial agreements with regard to financial assurances and reimbursement of costs, and address liability issues with respect to indemnification and insurance, covenants not to sue, and re-openers. Whenever EPA enters into an agreement where the PRPs are to perform the remedial actions, the agreement will be in the form of a consent decree. CDs are not the preferred mechanism for RI/FS or removal actions because administrative settlements may be processed more quickly.

If settlements are not achieved, there are several enforcement options available to EPA:

- C **Unilateral Administrative Orders (UAOs)** — UAOs are most commonly used to order PRPs to conduct cleanup activities when negotiations fail. UAOs are a powerful enforcement tool that EPA may use to help achieve PRP response. UAOs provide an especially effective method of achieving timely site cleanup. In removal situations where time is limited, UAOs may be issued without prior negotiations. PRPs may face statutory penalties of \$25,000 per day and costly litigation if they do not comply with the terms of a UAO. If the PRP is not cooperative, UAO issuance sets the stage for EPA to recover up to three times its response costs, known as *treble damages*.
- C **Litigation/Judgments** — If a PRP refuses EPA or another PRP access to the site, pursuant to section 104(e) EPA may seek a court order to obtain site access. Also, if EPA and the PRPs fail to reach an agreement that the PRPs will finance or conduct the cleanup, EPA may use section 106 authorities to order PRP cleanup or section 107 to recover its response costs. To pursue a judicial action, EPA refers the case to DOJ for filing with the court. Lawsuits are generally used as a last resort because they tend to be time consuming and costly. A *judgment* is a legally binding decision made by the court. It results from a section 104, 106, 107, or 106 /107 lawsuit.



There are several important settlement tools that EPA may use to facilitate **PRP** settlements. These include:

- C **Mixed Funding Settlements** — These are settlements whereby EPA settles with fewer than all PRPs for less than 100 percent of the response costs, and where EPA agrees to use Trust Fund money for some or all of the short fall. EPA then later seeks to recover the costs of that portion of the cleanup it funded. Also under this type of settlement, a PRP can agree to a mixed work settlement where the PRP provides cleanup services in lieu of funding.

- C **De Minimis Settlements** — These are final settlements that have been determined to be: (1) only a minor portion of the total response costs at the site, and (2) practicable and in the public interest. These settlements are used if the hazardous substances contributed by the PRP are minimal in amount and toxicity, in comparison to other hazardous substances at the site. A *de minimis* settlement may be incorporated into a global agreement with the major contributors and EPA.

- C **Non-Binding Allocations of Responsibility (NBARs)** — These are allocations of the costs of response among the PRPs, at a facility. The NBAR allocation process is based primarily on the volume of hazardous substances contributed by the PRPs, although other factors, (e.g., toxicity and mobility of the hazardous substances, and relative treatment costs) may be considered.

It is important to note that the objective of negotiations under EPA's settlement policy is to collect 100 percent of cleanup costs from PRPs or obtain a commitment from them to perform the entire response action at the site. When there is a partial settlement, it is very important to litigate against non-settlers as soon as possible. In most cases, this is a cost recovery action.

Oversight of PRP Work

The PRPs can begin work at the site once the AOC is signed or CD is entered into Federal Court. However, because of a time lag between when the court receives the CD for RD/RA and actually enters it as a final judgment, EPA encourages PRPs to begin the design activities for the remedy before the

CD is entered. EPA closely monitors all work at the site. This may include on-site examination of the PRPs or their contractors, review of all reports, and parallel sampling and analysis to ensure accuracy. CERCLA section 104 requires the PRPs to pay for EPA's RI/FS oversight expenses (including contractor support of EPA oversight efforts) as a part of the settlement. In other contexts, EPA seeks to obtain this reimbursement of oversight costs as a policy matter.

Cost Recovery

If negotiations with the PRPs are not successful, EPA may choose to perform the work and seek to recover its costs later. To recover its costs, EPA usually issues a demand letter, and if the PRPs do not reimburse EPA's costs, EPA refers a judicial action to DOJ to pursue the PRPs. If a total of \$500,000 or less in response costs are incurred at a facility, EPA may settle with the PRPs directly using an administrative order. If more than a total of \$500,000 in response costs is incurred at a site, written approval of the Attorney General is required if EPA settles the case administratively.

KEY PLAYERS IN THE ENFORCEMENT PROGRAM

The Superfund enforcement program requires close coordination between the many players in EPA, other Federal agencies, and the States. While roles may vary among the Regions, they generally include initiating negotiations, settlements, and cost recovery actions, and overseeing PRP response actions.

EPA

The **On-Scene Coordinators (OSCs)** and **Remedial Project Managers (RPMs)** play the lead role in planning and coordinating site removal, remediation and enforcement activities. In addition to personnel from Federal agencies and the States, other Regional staff (in particular, the Office of Regional Counsel (ORC), staff from the Environmental Services Division, and Community Relations), and Headquarters staff may play active roles.

Attorneys from ORC act as the Region's primary legal advisors whenever an enforcement action is being considered at a site. They may take the lead in negotiations with PRPs, review information exchanged between EPA and PRPs, assist in obtaining site access, review the administrative record, and act as the primary communication link between EPA and DOJ if EPA litigates against the PRPs.

Other Federal Agencies

In addition to EPA, the **Department of Justice** is significantly involved in the Superfund enforcement program. DOJ is involved in any enforcement action that must be filed in court and serves as a resource in all negotiations that may result in settlement. DOJ presents legal positions that explain EPA's goals to the court, and usually provides the only communication between EPA and the courts regarding site-specific litigation. In addition, DOJ is the official representative of EPA in negotiations that take place while a case is pending before a court. As noted earlier, the Attorney General must also approve any claim that is negotiated and settled, whether by consent decree or by administrative order on consent, where the total response costs at the site exceed \$500,000.

States

The role of States in the enforcement program is substantial but varies depending on whether the State is the lead or support agency at the particular site. If EPA has the lead, it must notify the State of planned negotiations and provide it with an opportunity to participate. Subject to the provisions of CERCLA section 121(f), States also have the right to be a party to any settlement. States may also perform oversight activities. If a State has the lead role at a site, it may negotiate directly with the PRPs and issue orders under State legal authority, and EPA assumes a support role.

Natural Resource Trustees

At any site where natural resources may have been damaged, EPA must coordinate with the trustee of those resources. The trustee may be a Federal agency, such as the Department of the Interior, the National Oceanic and Atmospheric Administration, or the Department of Agriculture, or it may be a State agency (designated by a governor), or there may be both Federal and State trustees for the site. EPA must notify natural resource trustees of settlement negotiations with PRPs and allow trustees to participate in negotiations of matters within their domain. Trustees are the only entities authorized to give PRPs assurances that they will not sue for damages to natural resources in settlement agreements.

SECTION V

REMOVAL ACTIONS

C OVERVIEW

C TYPES OF REMOVAL ACTIONS

- S** Emergency Removal Actions
- S** Time-Critical Removal Actions
- S** Non-Time-Critical Removal Actions

C CRITERIA FOR CONDUCTING A REMOVAL ACTION

C KEY PLAYERS

- S** EPA
- S** PRPs
- S** USCG
- S** Other Federal Agencies
- S** States
- S** Others

C STATUTORY LIMITS

C THE REMOVAL PROCESS

- S** Notification or Discovery
- S** Removal Site Evaluation
- S** Action Memorandum
- S** Response Action
- S** Site Closeout
- S** Post Removal Site Control

SECTION V REMOVAL ACTIONS

OVERVIEW

Removal actions are generally short-term response actions taken to abate or mitigate imminent substantial threats to human health and the environment and are generally surface cleanups. Removal actions can be triggered by burning, leaking, explosion, or other hazardous occurrences that cannot wait for remedial action. As a result of the short-term nature of these actions, CERCLA, as amended by SARA, sets \$2 million and 12 month limits on Trust Fund-financed removal actions.

Superfund removal actions have occurred in response to all of the following types of incidents:

- **Critical threat at an active or inactive production facility** — any incident at ongoing or former operations that manufacture(d), recycle(d), handle(d), store(d), or transport(ed) hazardous substances or waste as a primary ingredient, product, or by-product of operations or any location contaminated due to off-site migration of hazardous substances or wastes from such operations.
- **Critical threat at an active or inactive waste management facility** — any incident at an ongoing or former, legal or illegal, operation or site whose primary purpose is (was) to handle, exchange, transfer, store, treat, or dispose of hazardous substances or wastes from such a facility or site.
- **Midnight dump** — any illegal dumping of hazardous substances or suspected hazardous substances into the air, land, water, or other element, whether accidental or deliberate.
- **Transportation-related** — any release or potential release of hazardous substances due to a transportation situation, accident, or malfunction. (Local authorities usually respond to hazardous releases resulting from transportation-related incidents. The Superfund program also has the authority to respond, if necessary, under the removal program to such emergencies.)

- C **Other** — any release to the environment of hazardous substances that does not conform to one of the above categories and/or a release where the source of the contaminant is unknown.

Exhibit 3 illustrates the approximate distribution of removal actions according to the above types of incidents.

TYPES OF REMOVAL ACTIONS

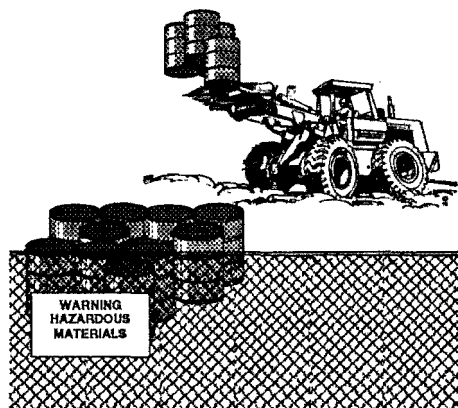

Each removal action is prompted by the unique circumstances of a release or potential release of hazardous substances. The following removal actions are generally appropriate in the situations described:

- C Fences, warning signs, or other security or site control precautions -- where restricted access is required
- C Drainage controls (e.g., run-off or run-on diversion) -- where needed to reduce migration of hazardous substances, pollutants, or contaminants off-site or to prevent precipitation or run-off from other sources (e.g., flood waters, from entering the release area from other areas)
- C Stabilization of berms, dikes, or impoundments, or drainage or closing of lagoons where needed to maintain the integrity of the containment structures
- C Placement of a cap on contaminated soils or sledges -- where needed to reduce migration of hazardous substances or pollutants or contaminants into soil, ground or surface water, or air
- C Utilization of chemicals and other materials to retard the spread of the release or to mitigate its effects -- where the use of such chemicals will reduce the spread of the release
- C Excavation, consolidation, or removal of highly contaminated soils from drainage or other areas -- where removal will reduce the spread of or direct contact with contamination
- C Removal of drums, barrels, tanks, or other bulk containers that contain or may contain hazardous ignitable or explosive substances or pollutants or contaminants -- where it will reduce the likelihood of spillage, leakage, and exposure to humans, animals, or the food chain

Exhibit 3
Removal Actions by Type of Incident

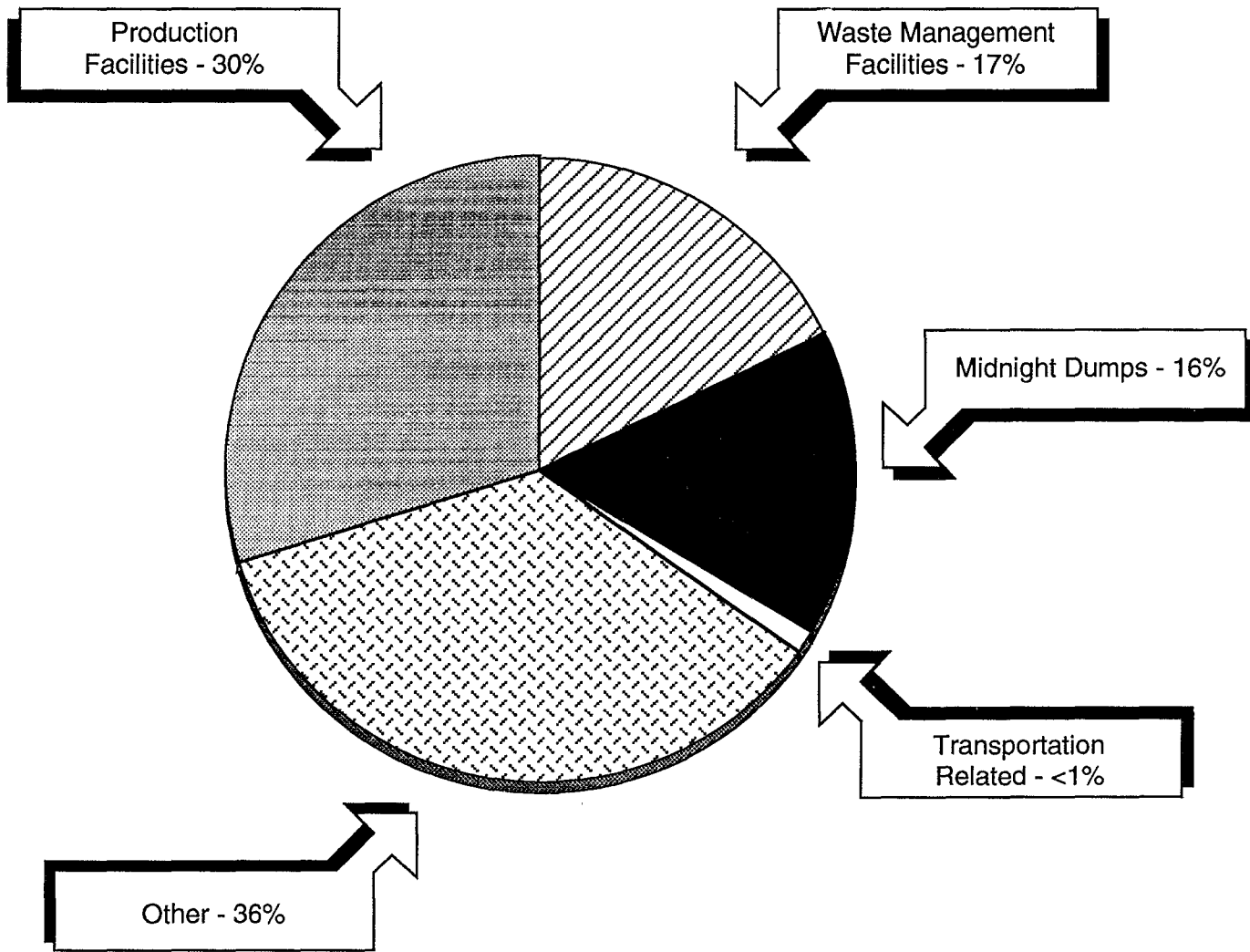

- C Containment, treatment, disposal, or incineration of hazardous materials -- where needed to reduce the likelihood of human, animal, or food chain exposure
- C Provision of alternative water supply - where it will reduce the likelihood of exposure to contaminated water.

If reported releases consist of oil, the CERCLA petroleum exclusion forbids CERCLA response. The CWA, and the amendments in the Oil Pollution Act of 1990 (OPA) provide the authority and funding for responses to oil spills into or threatening U.S. waters.

EPA categorizes removal actions in three ways, *emergency*, *time-critical*, and *non-time-critical*, based on the type of situation, the urgency and threat of the release or potential release, and the subsequent time frame in which the action must be initiated. Emergency and time-critical removals are in response to releases requiring action within six months; non-time-critical removals are in response to releases requiring action that can start later than six months.

Emergency Removal Actions

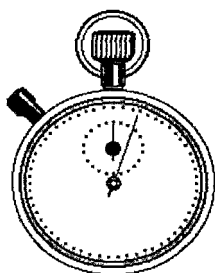

Emergency removal actions are necessary when there is a release that requires on-site activities within hours of the determination that a removal action is appropriate. Such removal actions are likely to occur as a result of:

- C Discovery of high concentrations of hazardous substances in human high traffic areas such as residential areas, alleyways, and recreational areas.
- C Fire or explosion at production facilities and hazardous waste treatment, storage, or disposal sites

Time - Critical Removal Actions

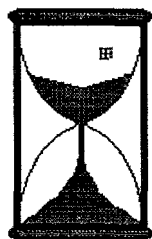

Time-critical removal actions are those where the lead agency determines, based on the site evaluation, that a removal action is appropriate and must be initiated within six months. Time-critical removal actions typically involve:

- C Dangerous concentrations of acutely toxic substances
- C Threat of rapid and/or wide off-site migration
- C Likelihood of fire or explosion
- C Acute threat to human health and/or environment.

*Non-Time-Critical Removal
Actions*

Non-time-critical removal actions are those where the lead agency determines, based on the site evaluation, that a removal action is appropriate but a planning period of more than six months is available before on-site activities must begin. Non-time-critical removal actions typically involve:

- C A secure site
- C No nearby population center
- C Storage containers in stable condition
- C A dangerous concentration of chronic toxic substances.

Examples of non-time-critical removal actions may include removal of stable drums discovered during a remedial action, or excavation of low-level radioactive materials from property with restricted access.

**CRITERIA FOR
CONDUCTING A REMOVAL
ACTION**

The National Oil and Hazardous Substance Pollution Contingency Plan (NCP) lists the following factors to consider in determining if a removal action is appropriate:

- Actual or potential exposure of hazardous substances to a human or animal food chain
- Actual or potential contamination of drinking water or sensitive ecosystems
- Threat of fire or explosion
- Hazardous substances in containers that pose a threat of release
- Highly contaminated soils at the surface that may migrate
- Weather conditions that may cause substances to migrate
- An imminent and substantial endangerment to public health, welfare, or the environment as a result of pollutants or contaminants, i.e., substances not already defined by CERCLA as "hazardous"
- Unavailability of other response or enforcement mechanisms.

The OSC uses the above criteria to determine if a removal action is appropriate, then also considers the following criteria for a proposed removal action:

- If financed by the Trust Fund, the potential response action should remain within the \$2 million/12 month statutory limits on removal actions set by CERCLA (unless an exemption based on urgency or consistency with a remedial action to be taken can be requested on a case-by-case basis).
- In general, sites or operable units with a signed Record of Decision (ROD) should not be cleaned up using removal authority.
- Most removal actions do not require extensive study or long-term response except, perhaps, non-time-critical removal actions.

EPA Regions have been delegated authority to consider exemptions to the one-year limit. EPA Headquarters, however, considers exemptions to the dollar limit for removal actions on a case-by-case basis.

KEY PLAYERS

The Superfund removal program is not performed by EPA alone. Many participants contribute to successful removal actions and to the program's overall success. Other participants may include:

- Potentially Responsible Parties (PRPs)
- U.S. Coast Guard (USCG)
- Other Federal Agencies
- States
- Contractors
- Citizens.

For most Trust Fund-financed, or CERCLA enforcement sites, EPA ultimately ensures that removal actions comply with all the requirements of the NCP, regardless of who participates in or leads the response action. However, in certain instances the USCG ultimately ensures that removal actions comply with all the requirements of the NCP.

EPA

EPA's Emergency Response Division (ERD), located at EPA Headquarters in Washington, D.C., is responsible for planning and coordinating the Superfund removal program.

OSCs

Much of the authority for daily operations is delegated to the ten EPA Regions. **OSCs** in each Region manage individual removal actions and are authorized to expend Trust Fund monies. Typically, they oversee contractors or PRPs who perform the actual cleanup work. OSCs may receive assistance during the course of a removal action from several specialized teams of experts within and outside of EPA. For example, the **Environmental Response Team (ERT)**, a part of ERD, includes biologists, chemists, environmental scientists, and engineers. These experts provide technical advice on all aspects of removal actions including sampling and analysis, site safety, cleanup techniques, and waste disposal.

PRPs

PRPs may undertake removal actions in response to EPA's issuance of an administrative order. Before issuing an administrative order, the OSC determines if PRPs or State / local agencies are able and willing to respond. If they are not able and willing and no one is responding, then a Trust Fund-financed removal action is necessary.

USCG

The **U.S. Coast Guard (USCG)** representative serves as the OSC for oil discharges and hazardous substance releases in the coastal zone. The USCG OSC shall contact the EPA remedial project manager (RPM) as soon as it is evident that the removal may require a follow-up remedial action.

Other Federal Agencies

Other Federal agencies that participate in the removal process include the Federal Emergency Management Agency (FEMA), the Agency for Toxic Substances and Disease Registry (ATSDR), the Occupational Safety and Health Administration (OSHA), and the National Oceanic and Atmospheric Administration (NOAA).

The Department of Defense (DoD) and the Department of Energy (DOE) have been delegated response authority, under Executive Order 12580, to conduct emergency and non-emergency removal actions with respect to releases or threatened releases from their own facilities. DoD and DOE must use their own resources to pay for any removal actions they conduct. EPA OSCs are frequently called upon to manage or assist at a DoD release which has the potential for migrating off-site or was released from a military reservation. All other Federal agencies are authorized to conduct non-emergency removal actions only.

States

A **State** may act as lead agency to carry out a Trust Fund-financed removal action through a cooperative agreement (CA) if EPA determines that it is a non-time critical removal and that this lead will result in the most efficient method of threat mitigation.

Others

A wide variety of special forces and teams, Federal agency resources, contractor support services, State, and other resources are available to assist the OSC in the removal process. The services of each organization are explained in the NCP and the Superfund Removal Procedures Manual.

For emergency and time-critical removal actions, citizens are provided an opportunity to comment on the proposed action within 60 days of its initiation. They provide this input during the public comment period when EPA makes the technical file that forms the basis for selecting the site remedy, the Administrative Record, available for public review. EPA responds to this input by providing information to the community and considering the concerns and interests raised. For non-time-critical removals, public comment is solicited prior to selection of the removal action. For more information regarding citizens' roles in the Superfund process, see Section X: Community Relations /Public Participation.

STATUTORY LIMITS

CERCLA, as amended by SARA, limits the cost and duration of Trust Fund-financed removal actions to \$2 million and 12 months. The \$2 million limit includes all obligations from the Trust Fund associated with a particular site, except for costs of studies or investigations that may be necessary or appropriate to plan and direct response actions or to recover costs thereof. The 12-month limit is calculated in calendar days from the date on-site removal work begins to the date of demobilization. However, in special circumstances, such as a continuing emergency or an action that will be consistent with future remedial activity, removal actions may exceed these limits.

A request for an exemption to the statutory limits may be approved if it is determined that:

- Continued response actions are immediately required to prevent, limit, or mitigate an emergency, *and*
- There is an immediate risk to public welfare or the environment, *and*

- Such assistance will not otherwise be provided on a timely basis, *or*
- The removal process is otherwise appropriate and consistent with the remedial action to be taken. (This waiver of the statutory limits is generally used at NPL sites but may be considered on a site-by-site basis at non-NPL sites).

If a removal action must be conducted at a remedial site and the remedial action has not yet been determined, the OSC should attempt to select a removal action that will be appropriate and consistent with the most probable remedial action(s) for that site.

THE REMOVAL PROCESS

The removal process involves several phases including a notification/discovery evaluation, remedy selection, response action, and project closeout. Exhibit 4 provides an overview of the removal process.

Notification or Discovery

EPA learns of hazardous waste problems through formal and informal mechanisms, either through **notification** or by **discovery**. CERCLA requires "the person in charge," who discovers a release of a hazardous substance above a certain threshold, to report the release to the National Response Center (NRC), a national clearinghouse that coordinates responses to reports of hazardous substance releases. These threshold levels, known as Reportable Quantities (RQs), vary depending upon the specific substance detected. Through 1991, EPA has established RQs for more than 700 hazardous substances, which are listed in 40 CFR Part 302. Releases are reported to the NRC by PRPs, the general public, State and local authorities, and Federal agencies. The NRC, which is staffed by the USCG and located in Washington, D.C., alerts the appropriate EPA Regional or USCG OSC.

Removal Site Evaluation

If the reported release appears to pose an imminent threat to human health and the environment, the OSC begins a **removal site evaluation**. The initial part of the evaluation is based on available information such as written reports, photographs, and interviews with witnesses. A site inspection is performed if more detailed information is needed.

Exhibit 4 The Removal Process

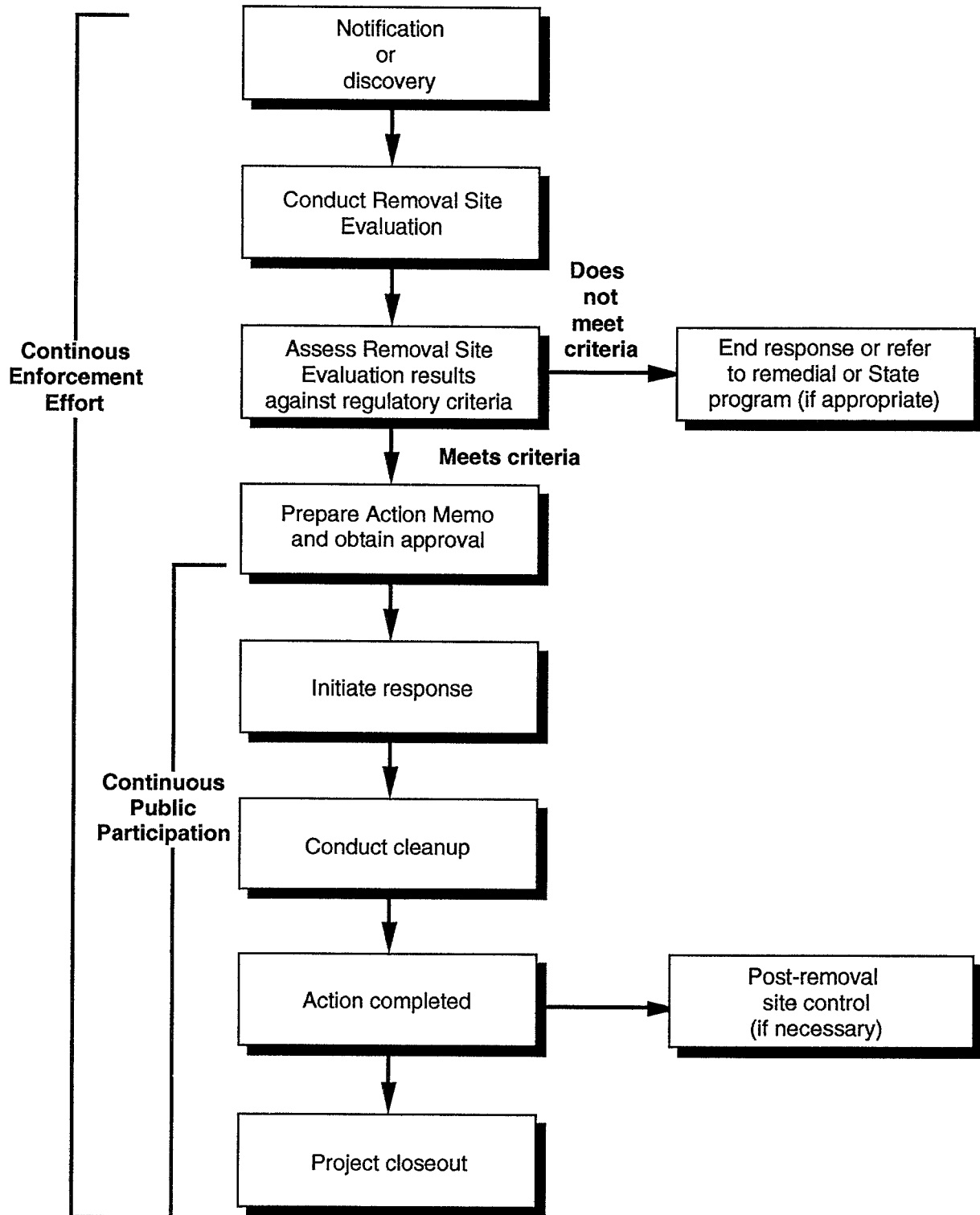

During a removal site evaluation, the OSC considers the type of contaminant, concentration and form, action levels, and mitigation options. According to the NCP, the removal site evaluation includes, but is not limited to:

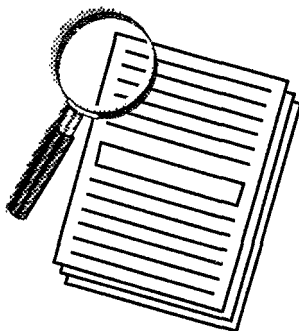

- Identification of the source and nature of the release or threat of releases
- Evaluation of the threat to public health
- Evaluation of the magnitude of the threat
- Evaluation of factors necessary to determine if a removal action is appropriate
- Determination if a non-Federal party is undertaking proper response.

Depending on the characteristics of the release and urgency of the situation, the evaluation may take only an hour or as long as several weeks.

A PRP search is also initiated during the removal site evaluation to identify and compel legally responsible parties to take corrective action. Factors to consider when determining the potential for PRP involvement in the response include the urgency of the release, status of enforcement activities, and financial capability of the responsible party.

Upon completion of the removal site evaluation, the evaluation is reviewed to determine if action is necessary. If action is necessary, it is documented that the time frame for response is more appropriate for a removal action than for a remedial response. After determining that a removal action is necessary, the OSC assesses whether the responsible party(s) or State can and will perform the necessary action. If the responsible parties are not identified during the PRP search, or they will not perform the necessary actions or neither the PRP or the State can perform the necessary actions, then a Trust-Fund financed removal action may be undertaken.

Action Memorandum

An **Action Memorandum** is the primary decision document that substantiates the need for a removal action, identifies the proposed response, and explains the rationale for the removal action. The Action Memorandum is the basis

for the actions described in an administrative order or a Trust Fund-financed removal action. An Action Memorandum also allocates funds for the response.

Response Action

The on-site **response action** is initiated once the Action Memorandum has been prepared and signed. For Fund-lead actions, EPA hires contractors and completes the actions in the Action Memorandum. For State or enforcement-lead action, EPA oversees the remedy to ensure that it is in compliance with any orders or agreements, Action Memorandum, and is protective of public health and the environment.

Site Closeout

At the conclusion of the removal action, certain **site closeout** procedures must be performed. The completion date of the action must be determined to signify that the action is complete, the threat is abated or mitigated, and that the project was completed within 12 months or within the timeframe approved in an exemption.

A final OSC report shall be completed. The OSC report records the situation as it developed, actions taken, resources committed, and problems encountered. The final step is ensuring that post removal site control measures will be maintained.

Post Removal Site Control

Post removal site control refers to those activities that are necessary to sustain the integrity of a removal action following its conclusion. These activities, such as relighting gas flares, replacing filters, and collecting leachate, are necessary for assuring the continuing effectiveness of a removal action after completion of the on-site removal activities or after the statutory limitations are reached. Generally, State, local governments, or PRPs assume responsibility for these activities.

Removal actions involve rapid response to eliminate, minimize, or reduce the threat of a hazardous substance release. The OSC is the key manager at a removal site and directs response efforts and coordinates all other efforts at the scene of a release or threatened release. The OSC directs Fund-lead efforts and reviews work of other Agencies, responsible parties, and contractors to assure compliance with the NCP. The OSC also reviews all decision documents, enforcement orders, and plans applicable to the response.

SECTION VI

SITE ASSESSMENT

- **OVERVIEW**
- **THE SITE ASSESSMENT PROCESS**
 - % Site Discovery
 - % Preliminary Assessment
 - % Site Inspection
- **HAZARD RANKING SYSTEM**
- **NATIONAL PRIORITIES LIST**

SECTION VI SITE ASSESSMENT

OVERVIEW

When Congress enacted CERCLA, it recognized that the cost of cleaning up all hazardous substance releases or potential releases nationwide would exceed the resources available in the Trust Fund. Therefore, Congress directed EPA, in section 105 of CERCLA, to include in the National Oil and Hazardous Substances Pollution Contingency Plan (NCP) criteria for determining *priorities* among releases or threatened releases throughout the United States for the purpose of taking response action. These criteria and priorities are based upon relative risk or danger to human health and the environment. To implement this mandate, EPA developed a scoring system to identify priority sites for cleanup using the Fund and a National Priorities List (NPL) of sites to be cleaned up. The scoring system is called the Hazard Ranking System (HRS). The HRS assesses the relative risk posed by sites. The HRS enables EPA to identify the priority sites and allocate Trust Fund monies accordingly.

THE SITE ASSESSMENT PROCESS

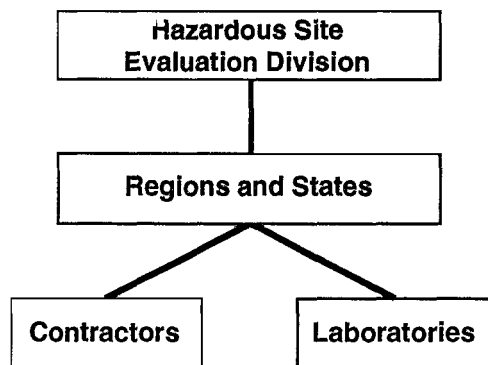

Site assessment is the initial phase of the Superfund response program. It is the process by which EPA and the States identify, evaluate, and rank hazardous waste sites. The Hazardous Site Evaluation Division (HSED), at EPA Headquarters, is responsible for directing Superfund's site assessment program, while the EPA Regions and the States actually implement the program.

The Regions work closely with the contractors and laboratories that perform site investigations and analyses. The States also perform various site assessment activities, often with funding provided through Cooperative Agreements with EPA. The Regions must ensure that Superfund program objectives are met and that pertinent site information is entered into the CERCLA Information System (CERCLIS).

CERCLIS is an inventory of all potential sites brought to EPA's attention. CERCLIS contains information on both potential and actual sites and the result of the site assessment process. It serves as a historical data base for EPA to keep track of EPA's work at each site. CERCLIS incorporates vital program, enforcement, financial, management, and technical data regarding sites.

Site assessment activities help identify and evaluate the most serious hazardous waste sites in the nation. These activities include the following five steps:

1. **Site Discovery** — when EPA first learns about hazardous substance releases or potential releases
2. **Preliminary Assessment** — a relatively low-cost review of existing site information to determine the need for further action
3. **Site Inspection** — a more in-depth assessment of on-site conditions and characteristics to determine if a site presents enough of a threat to qualify for the NPL
4. **Hazard Ranking System (HRS)** — a mathematical model applied to assess the relative risk posed by likely NPL sites
5. **National Priorities List (NPL)** — a list of sites that are eligible for Trust Fund-financed remedial action.

The site assessment process is illustrated in Exhibit 5.

At each stage of the site assessment process, sites are subject to one of several outcomes:

- **Referral to the removal program** — If the site presents an immediate danger to human health and the environment, it would be referred to the removal program. If a long-term threat remains at the site at the conclusion of the removal action, the site assessment process will continue.
- **Referral to the State or another environmental program** — If the information gathering process indicates that the State or a more appropriate regulatory program is available to address the problems at a site, the site may be referred to the State or that program for further consideration. CERCLA response authorities are to be used as a "last resource."
- **A decision for no further action under CERCLA** — If the assessments show no evidence of a hazardous substance present or if the site will not receive a HRS score that qualifies for NPL consideration, the investigation of the site may be discontinued or referred to the State.

Exhibit 5
The Site Assessment Process

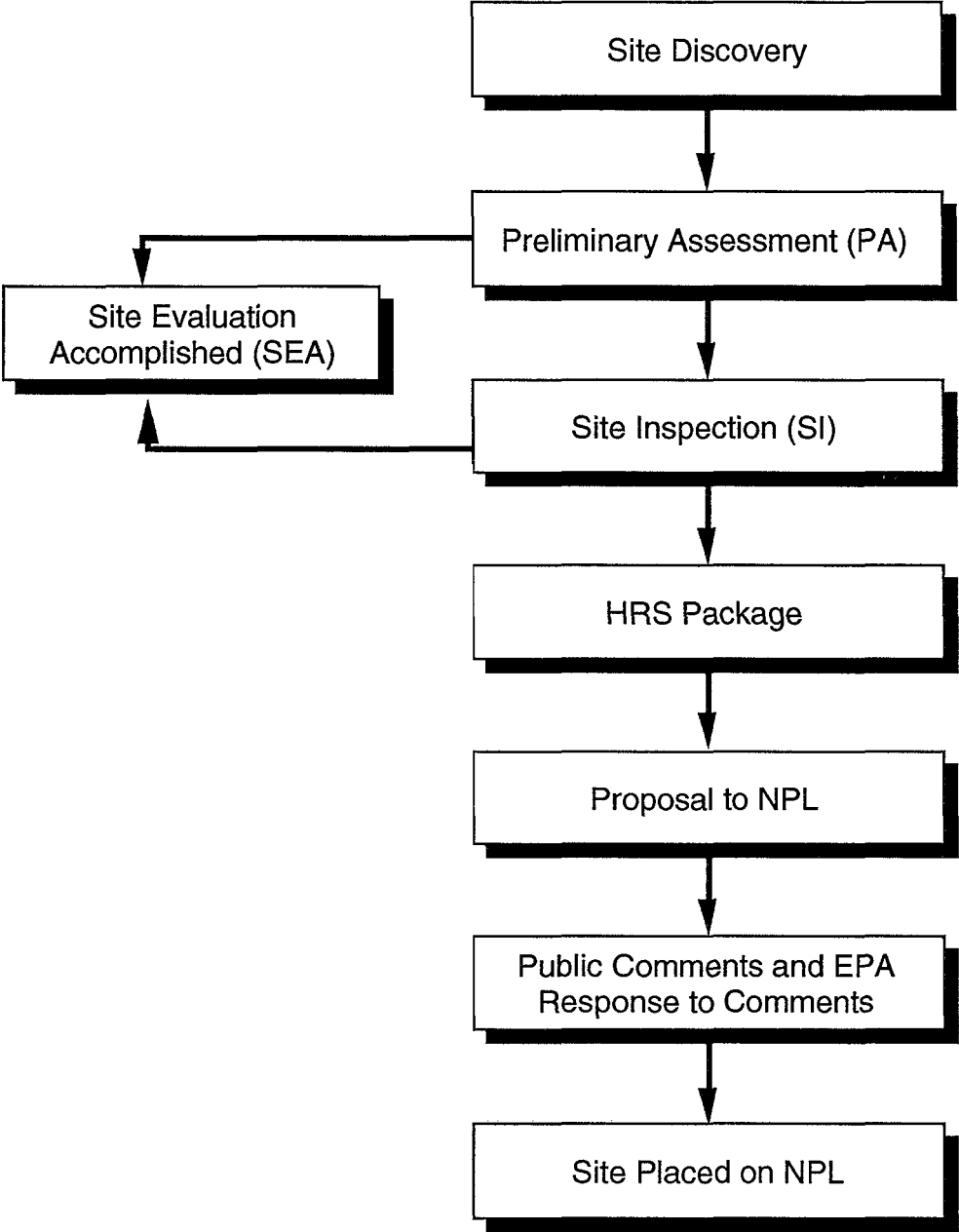

- C Continuation in the site assessment program**—If the site presents evidence of a hazardous substance, it continues through the assessment process potentially leading to NPL placement and remedial action.

It is important to recognize that EPA does not perform these site assessment activities alone. Many States have active site assessment programs supported by the Regions.

This section discusses in greater detail the guiding principles, objectives, and operating procedures for the five general steps in the site assessment process.

Site Discovery

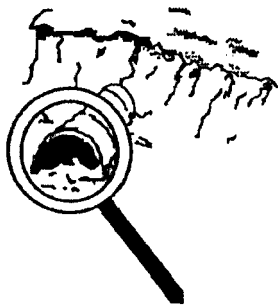

EPA discovers hazardous substance releases that potentially warrant Superfund response through several types of channels. These channels include:

- State and local programs
- Other Federal programs (e.g., DoD or DOE)
- Notification under CERCLA or RCRA reporting requirements
- Citizen complaints.

The majority of releases are discovered through State and local programs.

Once a site has been discovered, the enforcement process begins with a potentially responsible party (PRP) search. During this search EPA seeks to identify all parties who may be responsible for the release. As EPA identifies PRPs, EPA notifies the PRPs and requests information in order to support site assessment, identify other PRPs, and support other possible future actions. PRP search activities continue throughout the remedial process and generally begin in earnest during the site inspection/NPL stage.

Preliminary Assessment

The next step EPA takes after learning of a potential site or release is to obtain and review all available reports and documentation about the site. This step is called a **preliminary assessment (PA)**. Preliminary assessments are evaluations of existing site-specific data designed to determine whether sites merit further action under CERCLA. EPA collects background information not only from its own files but also

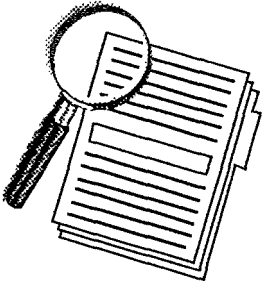

from State and local records and U.S. Geological Survey maps. During this assessment, EPA determines the size of the site, the types and quantities of substances most likely to have been released, the local hydrological and meteorological conditions, the population at risk, and the potential environmental impacts.

The objectives of the PA are to:

- Eliminate from further consideration under CERCLA those sites that do not pose threats to human health and the environment
- Determine the potential need for response action
- Set priorities for site inspections
- Gather data for the HRS score.

PAs are the only required, common step among all sites in CERCLIS. All sites must have a PA within one year of entry into CERCLIS.

PAs consist of collecting data and determining whether there are hazardous substance that pose a threat to human health and the environment. The purpose of PA data collection is to gather as much readily available information as possible about a particular site. The lead agency compiles Federal, State, and local files; private well logs; and geological, topographical, hydrological, and meteorological data. Additionally, the lead agency interviews Federal, State, and local personnel and examines other relevant records.

After completing the PA, EPA prepares a PA report, as required by the NCP. The report includes the potentially affected populations at a particular site, the site operating history, sources of contamination, and, if appropriate, hydrogeology and hydrology.

Sites can be eliminated from further CERCLA consideration as a result of the PA, with a decision that the **site evaluation is accomplished (SEA)**. SEA decision, following a PA, can be made if EPA concludes that there is no threat to human health or the environment. Also, a site will receive a SEA decision if there is no evidence of hazardous substances being present, if the site has already been investigated and no threat was

found, or if the risk from the site is not sufficient for inclusion on the NPL. The PA sites that have received SEA decisions are typically sites with few possibly affected populations within close proximity of the site and where there is a low likelihood of release of hazardous substances into the environment. The SEA decision can be made at any stage in the site assessment process, either during or after the preliminary assessment. If later information indicates the site may present a risk or potential risk, the SEA decision may be reviewed, and if necessary, further work or even listing on the NPL may result. It should be noted that response actions may, and often do, occur under State authority at sites that have received SEA decisions. Also, a SEA decision does not remove a site from CERCLIS.

Site Inspection

EPA requires a **site inspection (SI)** if the preliminary assessment indicates a suspected or potential release of hazardous substances that may threaten human health or the environment. Site inspections build upon and supplement the information collected during the preliminary assessment. The purposes of the site inspection are to:

- Determine the potential need for a removal action
- Determine whether further Superfund action is warranted as a result of a significant threat to human health or the environment
- Collect additional data regarding contamination and risks to further evaluate the release pursuant to the HRS and the RI/FS, as appropriate.

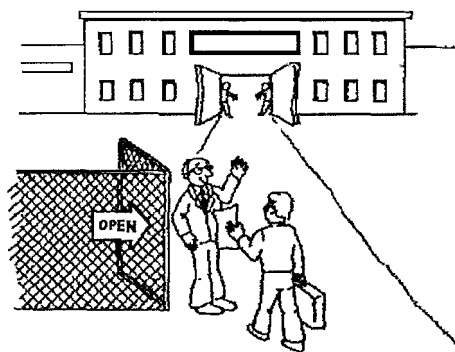

During the SI, the lead agency collects and analyzes three types of information necessary to develop an HRS score: (1) desktop data; (2) non-sampling data; and (3) sampling data. *Desktop data* are available from accessible sources, such as topographical maps, well logs, and on-line data bases. Bibliographic information too extensive to review during the PA may also be used. *Non-sampling data* about a site and its environment are gathered in the field on a reconnaissance trip. Examples of non-sampling data collection include gathering the source volumes and area measurements, verifying possibly affected resources (e.g., ground water, surface water, air), and verifying observable and measurable physical characteristics about the site. Information is gathered

regarding the types of soils on site, streams or rivers on or near the site, number of people in the area, weather conditions, and who owns, or operates the site.

Sampling data are collected during a site visit. These samples help to quantify what types of hazardous substances are present at the site, how much of these substances has been released, and what potential targets have been contaminated. Samples of wastes, soil, surface water and sediments, well water, and air are collected to determine what hazardous substances are on the site. Samples are also taken nearby to determine if and how far the substances may have migrated away from the site.

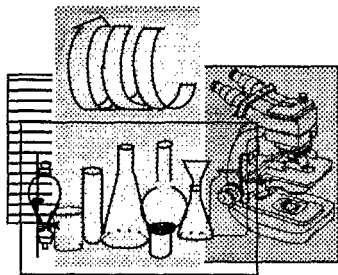

The primary objective of this inspection of site characteristics is to collect information to rank the site's hazard potential, i.e., document an HRS score to the extent required for a decision on whether the site qualifies for the NPL. The procedures performed during an SI vary somewhat because of differences in information needs and site characteristics. Often the initial SI is conducted to collect the sampling data necessary to document an HRS score. However, if this SI does not produce enough data to prepare an HRS score, a more extensive SI, called an expanded site inspection (ESI), may be necessary to gather additional sampling data. Both the SI and the ESI support EPA's decision concerning a response action that may be required at a site. A site can receive a SEA decision at any point in the process if it becomes apparent the site will not go onto the NPL.

HAZARDOUS RANKING SYSTEM

CERCLA mandated that a screening mechanism be established to evaluate a site's relative risk and determine its eligibility for the NPL. EPA, in response, developed an approach to systematically score sites that have been discovered. This model is known as the **Hazard Ranking System (HRS)**. It enables EPA to identify the possible or actual risks at each site, assign numerical scores to those risks, and compare the relative severity of risks among sites after a site inspection is performed. A site must have a total score of 28.50 or above to be proposed for the NPL. The HRS is a screening tool, it is not a risk assessment.

CERCLA mandates that the screening model take into account, to the maximum extent possible:

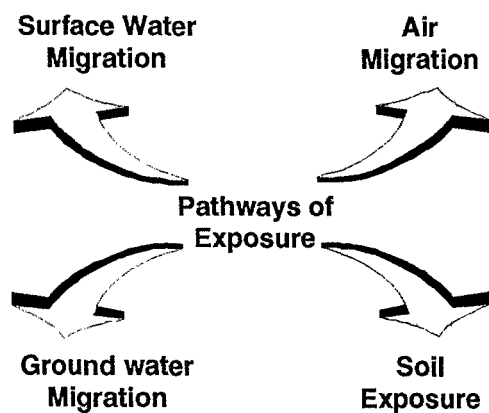

- The population at risk
- The potential for drinking water contamination
- The potential for direct human exposure
- The potential for ecosystem impacts
- Damages that may affect the human food chain
- Health risks due to contamination of surface water or ground water
- Actual or potential contamination of ambient air.

The HRS examines four pathways of exposure: (1) groundwater migration; (2) surface water migration; (3) soil exposure; and (4) air migration.

The score is based on a calculation of factors within each pathway. The factor categories are: likelihood of release, waste characteristics, and targets (i.e., potentially affected populations, etc.). The information for the HRS is from the PA, SI, and ESI, which are the steps EPA uses to develop and refine the site information. As the site assessment process proceeds and more data are collected, the accuracy of the data increase. The information collected and EPA's decision at each stage of the process determines the fate of a site, i.e., whether or not a site will continue to be considered for inclusion on the NPL. After the completion of the SI, the Region conducts an evaluation to decide whether to prepare an HRS package for a site and to propose a site for the NPL. The HRS package contains the documentation that supports the data for the score, e.g., worksheets, historical data, maps, PA and SI reports.

Once the HRS package is completed and has been reviewed in the Region, it is submitted to EPA Headquarters for a quality assurance (QA) review. Following the QA review, eligible sites are submitted by the Region to Headquarters for proposal to the NPL.

The HRS score does not necessarily provide an indication of the feasibility, desirability, or nature of the remedial action that may be undertaken; the score is one of many factors used to prioritize sites for remedial action.

NATIONAL PRIORITIES LIST

Hazardous waste sites must be included on the **National Priorities List (NPL)** in order to be eligible for Trust Fund-financed remedial action. EPA determines which sites to include on the NPL by evaluating the relative risks of sites in

CERCLIS. In assessing relative risks, EPA implements section 300.425 of the NCP which specifies three ways sites may become eligible for the NPL:

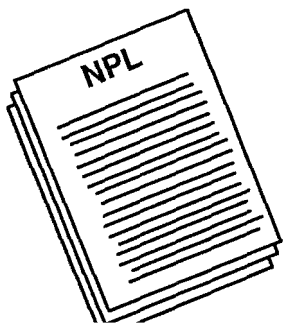

- The site has an HRS score of at least 28.50
- Each State is given one opportunity to designate one site, which it considers its highest priority, for the NPL
- The site meets all three of the following criteria: (1) the Agency for Toxic Substances and Disease Registry has issued a health advisory recommending that people be disassociated from the hazardous substances to avoid exposure; (2) EPA determines that the site represents a significant threat to human health or the environment; and (3) EPA determines that remedial action is more cost-effective than removal action.

Development of the NPL requires close cooperation among EPA Headquarters, the Regions, and the State agencies involved. Since the NPL is a rule, adding a site to the NPL must be accomplished through a rule-making process. This process can be divided into three stages: the rule proposal stage, the public comment period, and the final rulemaking phase.

The rule proposal stage begins when the Regions submit HRS packages for a Headquarters quality assurance review. Those sites that still have an HRS score of 28.50 or above after the QA process qualify for NPL listing. The resulting proposed list is subject to internal review and approval by the Office of Management and Budget (OMB). After OMB approval, EPA publishes the proposed rule, including the list of sites, in the Federal Register.

Next, the published proposed rule is subject to a 60-day public comment period. This comment period allows the public to review information about the proposed sites and to comment in writing on specific sites. To ensure citizen involvement, EPA establishes a public docket for each site that includes the HRS package and the site summary. These dockets are located in EPA Headquarters and in the respective Regional Office. In addition to comments from the general public, EPA receives comments from government agencies, industries, environmental groups, and trade associations.

EPA must respond in writing to all comments received during the public comment period, and these responses must be made available to the public. The responses appear in a support document issued at the time a final decision on sites appears in the Federal Register.

It is possible to have a site's score drop as a result of additional information received. If the score drops below 28.50, the site would not be placed on the NPL. Many of these sites become the responsibility of the States. All sites, however, remain listed in CERCLIS.

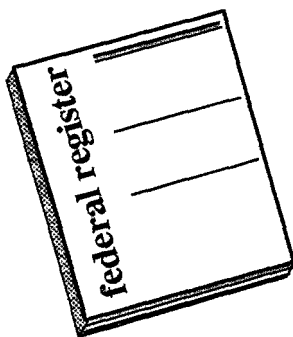

Once all of the public comments on a site have been addressed, EPA compiles a *final rule* along with a support document that includes all of the comments received and EPA's responses. The final rule is then reviewed by OMB, signed by EPA's Assistant Administrator of the Office of Solid Waste and Emergency Response, and published in the Federal Register. Through this process, sites become officially part of the NPL and, as a result, qualify for CERCLA remedial action funds.

CERCLA requires that the NPL be updated at least once a year. EPA schedules two NPL proposals a year and two NPL rules a year.

SECTION VII

REMEDIAL ACTIVITY

C OVERVIEW

C REMEDIAL PROCESS

S Who Takes the Lead?

C REMEDIAL INVESTIGATION

S Project Scoping

S Site Characterization

S Treatability Studies

C FEASIBILITY STUDY

S Development and Screening of Alternatives

S Detailed Analysis of Alternatives

C SELECTION OF REMEDY

S Proposed Plan

S Record of Decision

C REMEDIAL DESIGN

C REMEDIAL ACTION

C OPERATION AND MAINTENANCE

SECTION VII REMEDIAL ACTIVITY

OVERVIEW

Once EPA places a site on the National Priorities List (NPL), it becomes eligible for Trust Fund-financed long-term remedial activity. For these priority hazardous substance sites, cleanup is a long, complex process that may take millions of dollars and many years to complete. Remedial actions at NPL sites are designed to provide permanent solutions to mitigate risk to human health and the environment from the release of hazardous substances to the maximum extent practicable. Remedial sites typically have multi-media contamination (soils, surface water, ground water) by many different types of chemicals. The sites, which may encompass acres, or even miles, often must be broken up into several portions called "operable units" in order to address all of the problems at the site.

Section 121 of CERCLA requires, to the extent practicable, that Superfund remedial actions comply with the methods, procedures, and criteria outlined in the National Oil and Hazardous Substances Pollution Contingency Plan (NCP). CERCLA also requires that remedial actions:

- C Protect human health and the environment
- C Comply with Federal and State applicable or relevant and appropriate requirements (ARARs) unless exempted by a waiver
- C Utilize permanent solutions and alternative treatment technologies to the maximum extent practicable
- C Be cost-effective
- C Include State and community participation.

Also, EPA promotes the implementation of innovative technologies in responding to hazardous substance releases and waste sites.

THE REMEDIAL PROCESS

The remedial process requires extensive data gathering and analysis to characterize scope of the problem and the potential threats to human health and the environment.

Who Takes the Lead?

The Superfund program allows for EPA to conduct remedial activity, or EPA to enter into site-specific agreements to allow other agencies and/or groups or parties to conduct remedial activity. The agency or group that plans, carries out, and/or finances the cleanup is known as the **lead agency/group**. Agencies or groups that assist the lead agency by participating in the cleanup are known as **support agencies/groups**.

There are three possible leads for a remedial action, Fund-lead, State-lead, or Enforcement-lead. In a Fund-lead, EPA is the lead agency and assigns responsibility for managing and conducting the work to either the Alternative Remedial Contracting Strategy (ARCS) contractors, U.S. Corps of Engineers (USACE), or the U.S. Bureau of Reclamation (BuRec). A State, local agency, or Indian Tribe is the lead in a State-lead response. In an Enforcement-lead, responsible parties following court orders or settlement agreements are the lead.

For Trust Fund-financed remedial actions, CERCLA states that the State must first contribute 10 percent of the cleanup costs for sites that were privately owned or operated and 50 percent or more of costs for sites that were operated by the State. Once EPA, having consulted with the State, certifies that the remedy is working properly and has met the remedy's objectives, the State finances and carries out operation and maintenance activities. However, EPA is always ultimately responsible for the success of a response taken under CERCLA authorities, regardless of who has the lead role in the Superfund remedial activity.

The remedial process includes steps to develop, design, and conduct a remedial action. Remedial actions are long term actions that stop or substantially reduce a release or threatened release, and are taken only at sites on the NPL. The remedial process is made up of the following six phases:

- C Remedial Investigation
- C Feasibility Study
- C Selection of Remedy
- C Remedial Design
- C Remedial Action
- C Operation and Maintenance.

Each of these six phases is shown in Exhibit 6 and discussed in greater detail below.

Exhibit 6 The Remedial Process

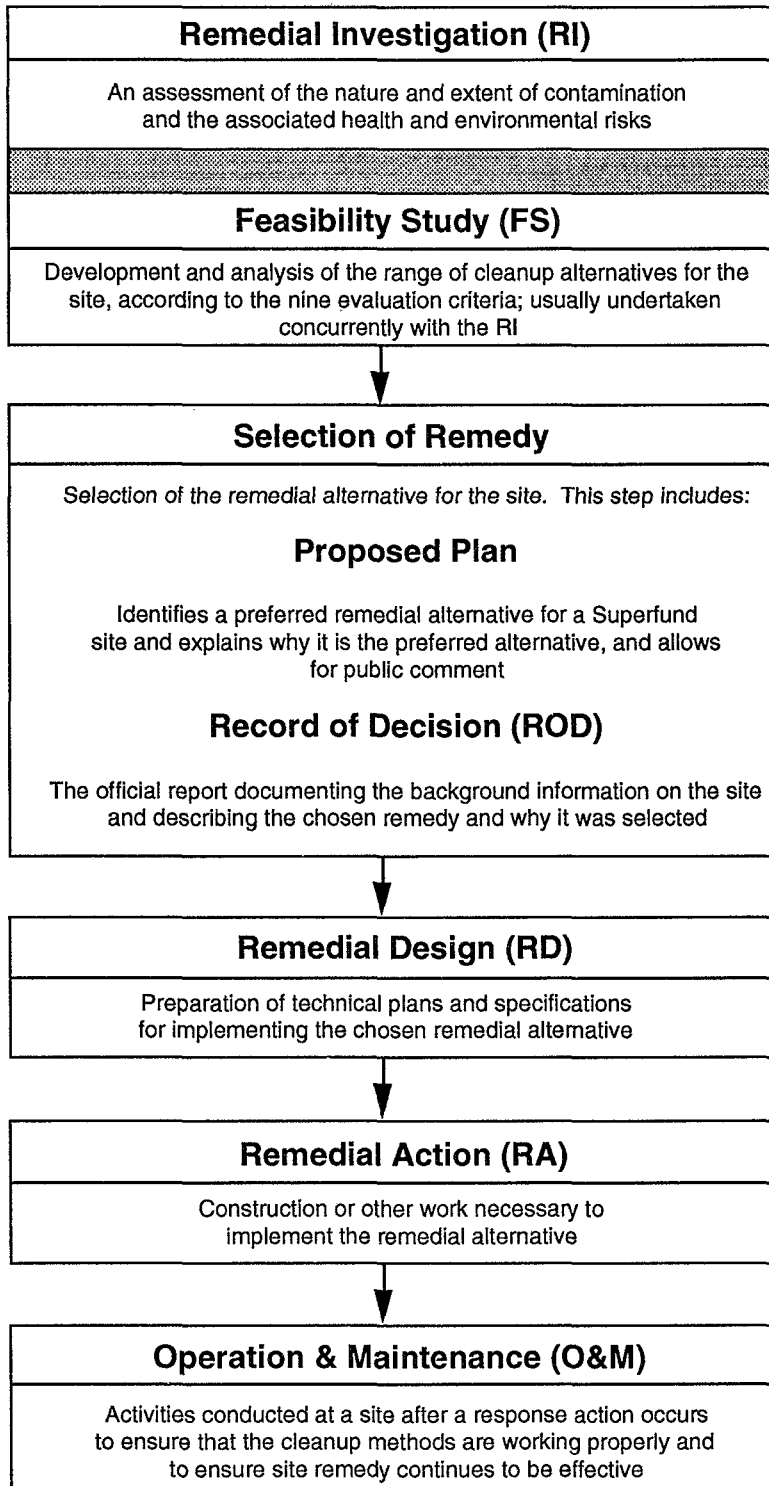

REMEDIAL INVESTIGATION

Once a site is placed on the NPL, the lead agency must perform or oversee a **remedial investigation (RI)** to further assess the site's problems. Similar to the initial site inspection prior to listing on the NPL, this involves an examination of site characteristics in order to better define the problem.

The remedial investigation, however, is much more detailed and comprehensive than the initial site inspection. The RI is designed to define the nature and extent of the problem and to provide information needed to develop and evaluate cleanup alternatives. It determines the existence and nature of any actual threat that may be posed to human health or the environment, and defines the extent of the threat posed to human health or the environment by any contamination that is found at a site.

The remedial investigation can be broken out into three main phases:

- Project Scoping
- Site Characterization
- Treatability Studies.

Project Scoping

Scoping is the initial planning phase of the RI and is continued and refined as new information about the site becomes available. During scoping, the lead and support agencies first identify the type and optimal sequence of site activities. Scoping involves the following seven steps:

1. **Conduct site kickoff meetings** — to begin site management planning, review and assign RI activities, and establish lines of communication among key personnel.
2. **Evaluate existing data** — to characterize the site to the extent necessary to support subsequent decisions. Existing data may include site data gathered during the NPL listing process and the search for PRPs, information from present or past site owners, historical and aerial photographs, records of disposal practices and operating procedures, regional geology and hydrology, land use information, and the location of sensitive environmental areas, supply wells, and surface water use on or near the site.

3. **Conduct site visit** — to identify the site's physical characteristics (e.g., waste sources, areas of contamination, potential exposure pathways, and potential receptors at or near the site) through field notes and photographs, and note any changes or discrepancies from existing data.
4. **Develop conceptual site model** — to evaluate potential risks to human health and the environment and to assist in identifying and setting priorities for the activities to be conducted at the site. The site model can be either a pictorial or computer-based graphic representation of site dynamics. It illustrates potential sources of contamination, types of contaminants and affected media, release mechanisms and potential contaminant pathways, and actual and potential human and environmental receptors.
5. **Identify preliminary remediation goals and general response actions** — to establish specific goals for protecting human health and the environment. Once a conceptual understanding of the site is obtained, preliminary remediation goals are identified for each chemical and medium to be addressed. Then general response actions for each chemical and medium are developed. These general response actions may later be combined or refined into specific remedial action alternatives. The preliminary remediation goals are modified as more information is developed concerning the site and the general response actions.
6. **Initiate identification of potential applicable or relevant and appropriate requirements (ARARs)**— to assist in identifying preliminary remediation goals and alternatives and providing better planning of field activities. ARARs are identified and refined as a better understanding is gained of site conditions, site contaminants, and remedial action alternatives.
7. **Identify initial data needs and data quality objectives** — to determine the type and quality of the data needed for the intended use of the data (e.g., health and safety planning, site characterization, remedial alternatives evaluation, or risk assessment). Once the data needs are identified, the strategies for sampling and analysis are

developed and the data quality objectives (DQOs) are established. The DQOs specify the quality of data required during the different phases of the RI and Feasibility Study (FS).

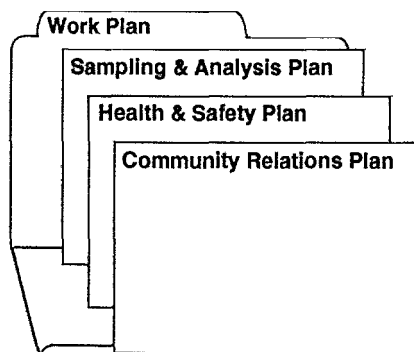

The seven steps of the scoping phase result in the development of the **Work Plan**. The Work Plan documents the decisions and evaluations made during scoping and describes the tasks required to conduct the RI and FS.

The work plan includes several other related project plans that are derived directly from information gathered during scoping. These include the Sampling and Analysis Plan, the Health and Safety Plan, and the Community Relations Plan. The *Sampling and Analysis Plan* is prepared so that sample collection activities are conducted in accordance with technically acceptable protocols and that the data collected in the field meet the DQOs established during scoping. The *Health and Safety Plan* identifies potentially hazardous operations and exposures and prescribes appropriate protective measures for on-site workers, the surrounding community, and the environment. The *Community Relations Plan* documents the issues of community concern at a site and describes the objectives of the community relations activities and how these objectives will be met.

Site Characterization

The **site characterization** phase of the RI builds on activities initiated during the scoping phase and includes implementation of the project plans mentioned above. Field data are collected and analyzed to determine the problems posed by the site and to support the identification of potential remedial actions. The following six activities are undertaken during the site characterization phase:

1. **Conduct field investigations** — to define a site's physical characteristics and its sources, nature, and extent of the threat posed by the contamination.
2. **Perform sample analysis** — to analyze the samples gathered during the field investigation. The data are then evaluated and must be carefully managed to allow them to be used to support remedy selection and any legal or cost recovery actions.

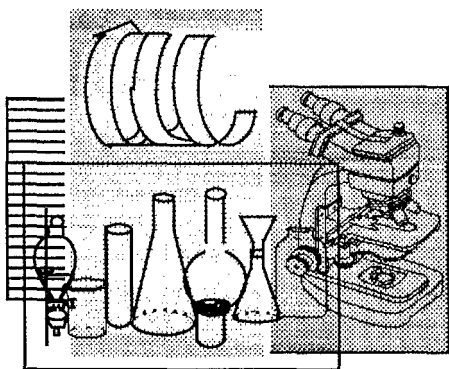

3. **Define nature and extent of threat posed by contamination** — to determine the actual and potential magnitude of releases from the sources and the mobility and persistence of source contaminants. The various contaminant pathways (e.g., air, ground water, etc.) are identified and studied.
4. **Conduct baseline risk assessment for various exposure routes** — to identify and characterize the current and potential risks that the site poses to human health and the environment.
5. **Further identify ARARs** — to use the new information about the site to investigate and identify more specific ARARs. Identification of ARARs is initiated during the scoping phase and is continued throughout the site characterization phase.
6. **Evaluate additional data needs** — the data collected and compiled are evaluated to determine if: a) the DQOs have been met; b) the risks posed by the site have been adequately defined; c) the need (or lack of need) for remedial action is documented; and d) the data necessary for the development and evaluation of remedial action alternatives have been obtained.

Treatability Studies

Treatability studies provide data to support remedy selection and implementation. Treatability studies help to support CERCLA's requirement that EPA select remedies that "utilize permanent solutions and alternative treatment technologies or resource recovery technologies to the maximum extent practicable." Treatability studies should be performed as soon as it becomes apparent that the available information is insufficient to support the selection of a potential treatment technology.

During the scoping process, a literature survey is often conducted to gather information on various technologies that might remediate the unacceptable risks. The literature survey is designed to identify each technology's applicability, performance, implementability, relative costs, and operation and maintenance requirements. If the considered technologies have not been sufficiently demonstrated or cannot be adequately evaluated on the basis of available information, **treatability studies** are then performed.

For a technology that has performance and cost data, bench-scale tests are usually sufficient to evaluate performance on new waste types. Pilot-scale tests may be necessary if information needed to operate the technology at full scale is limited, if there is a need to investigate secondary effects of the process, or if the waste being tested is complex or unique.

Following the treatability tests, an evaluation report is prepared that analyzes and interprets the test results considering the technology's effectiveness, implementability, environmental impacts, and cost. This report is incorporated into the overall RI report and is available for public review.

FEASIBILITY STUDY

EPA develops alternatives for remedial action and carefully compares the advantages and disadvantages of each alternative. This analysis of alternatives is called a **feasibility study (FS)**. In an FS, options for cleaning up the site are considered, described, and evaluated against nine criteria. The FS is comprised of two main phases:

- Development and screening of alternatives
- Detailed analysis of the alternatives.

It is important to note that, the FS is performed concurrently with the RI. This is because the data collected in the RI influences the development of remedial action alternatives in the FS, which in turn affects the data needs and scope of treatability studies and subsequent field studies.

Development and Screening of Alternatives

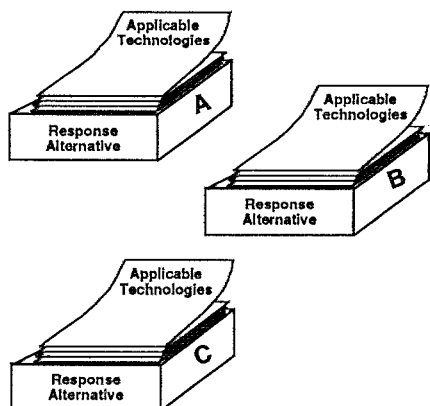

In the first phase of the FS, the general response actions, which meet the preliminary remediation goals developed during the RI scoping, are further developed and refined into specific remedial action alternatives. The alternatives may range from treatment of the principal threat to engineering controls supplemented by institutional controls for low-level contaminants and wastes for which treatment is impracticable. This phase of the FS includes the following seven components:

1. **Refine remediation goals** — to refine the preliminary remediation goals for protecting human health and the environment. The preliminary remediation goals, identified during project scoping, specify the contaminants and media of concern, the exposure routes and receptors, and the remediation levels for each chemical.

2. **Develop general response actions** — to refine and relate the response actions to basic methods of protection, such as treatment or containment. The general response actions were originally defined during project scoping for each medium of concern, and they now are refined. The volume or area to which general response action might be applied and the potential actions identified may be combined to form alternatives.
3. **Identify and screen appropriate technologies** — to list and evaluate potentially applicable technologies and technological process options. These options include the specific alternative processes within each technology, i.e., ion exchange or use of a soil-clay cap. The list is then reduced by evaluating the process operations with respect to technical implementability. Existing information on technologies and site characterization data are used to screen out options that cannot be effectively implemented at the site.
4. **Select representative process options** — to simplify the development and evaluation of remedial action alternatives. Based on the identification and screening of technologies, one representative option is selected, if possible, for each technology type remaining after the screening. During remedial design, other process options may be selected if they are found to be more advantageous.
5. **Reevaluate data needs** — to add any data that may be needed to assess potential process limitations or to establish remedial design criteria. Treatability studies are often needed when treatment is identified as a viable alternative. These studies provide data on technologies and their effectiveness on a specific waste found at a site.
6. **Assemble technologies into alternatives** — to combine the general response actions into specific remedial action alternatives to meet all of the remediation goals. For example, an alternative may call for incinerating the most highly contaminated soil from a portion of the site, and for capping other less contaminated areas. Consideration is given to how general response actions can be integrated in the most efficient ways.

7. **Screen alternatives, if required** — to focus the number of remedial action alternatives so that only the most viable alternatives will undergo a detailed analysis. If a large number of viable alternatives remains after the assembly of alternatives, this additional screening process is used. Three screening categories are used to reduce the number of alternatives: a) short- and long-term effectiveness and reductions achieved in toxicity, mobility, or volume; b) implementability including technical and administrative feasibility; and c) grossly excessive in cost.

At the completion of this phase, the problems of the site have been investigated. In addition the remediation goals are defined and the development and screening of remedial action alternatives has been completed. At this point, the remaining remedial action alternatives along with a no action alternative undergo a detailed analysis to identify the most effective option that best satisfies the statutory mandates.

Detailed Analysis of Alternatives

Once the cleanup alternatives have been assembled, screened, and defined, EPA evaluates them according to nine criteria. These evaluation criteria are the standards by which all the alternatives are assessed and are the basis of the remedy selection process. They can be separated into three levels: threshold, balancing, and modifying. The first two criteria are known as *threshold criteria* because they are the minimum requirements that each alternative must meet in order to be eligible for selection as a remedy:

1. **Overall protection of human health and the environment** — Addresses whether a remedy provides adequate protection of human health and the environment from unacceptable risks posed by hazardous substances, pollutants, or contaminants present at the site by eliminating, reducing, or controlling exposures through treatment, engineering, or institutional controls.
2. **Compliance with applicable or relevant and appropriate requirements (ARARs)** — Addresses whether the alternative attains all ARARs under Federal environmental laws or State environment or facility-siting laws or provides the grounds for invoking one of the six ARAR waivers stated in the NCP.

After criteria 1 and 2 are applied, EPA considers evaluation criteria 3 through 7. These next five criteria are known as the *balancing criteria*. These criteria are factors with which tradeoffs between alternatives are assessed so that the best option will be chosen, given site-specific data and conditions:



3. **Long-term effectiveness and permanence** — Refers to the ability of a remedy to maintain reliable protection of human health and the environment over time, once remedial action goals have been met. Permanence for this criterion is viewed along a continuum, and an alternative can be described as offering a greater or lesser degree of permanence.
4. **Reduction of toxicity, mobility, or volume** — Assesses the relative performance of recycling or treatment technologies on the toxicity, mobility or volume of contaminants.
5. **Short-term effectiveness** — Addresses the adverse impacts on human health and the environment that may be posed in the time it takes to implement the remedy and achieve the remediation goals.
6. **Implementability** — Looks at the technical and administrative feasibility of the remedy, including the availability of materials and services needed to implement each component of the option in question.
7. **Cost** — Includes estimated capital and operation and maintenance costs, and net present value of capital and operation and maintenance costs

The final two criteria are called *modifying criteria* because new information or comments from the State or the community may modify the preferred remedial action alternative or cause another alternative to be considered. These last criteria are:

8. **State acceptance** — Addresses the State's comments and concerns for each potential remedy. Indicates whether the State concurs with the preferred or the selected remedy. This assessment may not be completed until comments on

the RI/FS are received, but it may be discussed to the extent possible in the Proposed Plan.

- 9. Community acceptance** — Summarizes the public's general response to the alternatives described in the Proposed Plan or the FS. This assessment includes determining which of the alternatives interested persons in the community support, have reservations about, or oppose. This assessment may not be completed until comments on the Proposed Plan are received.

SELECTION OF REMEDY

The **remedy selection process** begins when EPA or the lead agency identifies a preferred remedial action alternative from among those evaluated in detail in the FS by the lead agency, in consultation with the support agency. The preferred action is presented to the public in a Proposed Plan, issued for comment with the RI/FS. Upon receipt of public comments on the Proposed Plan, the lead agency consults with the support agency to determine if the preferred action remains the most appropriate remedial action for the site. The final remedy is selected and documented in a Record of Decision (ROD). Although PRPs may conduct the RI/FS (except the risk assessment component), they may not select the remedy or write the ROD. Only EPA, or in limited cases the State, may do these things. The Proposed Plan and the ROD are the two main components of the remedy selection process.

Proposed Plan

Section 117(a) of CERCLA requires preparation of a **Proposed Plan** as part of the site remediation process. The Proposed Plan is a public participation document that addresses threat to human health and the environment and:

- Highlights key aspects of the RI/FS
- Provides a brief analysis of remedial action alternatives under consideration
- Explains the rationale for the preferred alternative
- Solicits public review and comment on all alternatives presented.



To solicit public comments, a notice and brief analysis of the Proposed Plan are published in a major local newspaper of general circulation. In addition, the Proposed Plan is made available at an information repository near the site.

The Proposed Plan can be written in a fact sheet format or an expanded format. Since it is a public participation document, the Proposed Plan outlines the procedures in order to inform and educate the public. It starts with a general introduction, site background, scope of the response action and summary of site risks. Each of the remedial action alternatives evaluated in the detailed analysis of the FS is summarized, including how each contaminated medium will be remedied, the estimated construction and operation and maintenance costs, and the implementation time of each alternative. The preferred alternative is identified, although it is pointed out that the selection of this alternative is preliminary and could change in response to public comments or other new information. The nine evaluation criteria are introduced and the preferred alternative is compared to the other alternatives with respect to the criteria. The Proposed Plan concludes with a summary of the findings and a section that explains how the public can become involved.

The public is given the opportunity for a public meeting to discuss issues related to the site and to submit oral and written comments to EPA during the 30-day public comment period. This comment period may be extended to 60-days upon timely request. Following receipt of public comments and any final comments from the support agency, the remedial action is selected and the rationale is documented in the ROD.

Record of Decision



The **Record of Decision** is the final remedial action plan for the site. The purpose of the ROD is to document the remedy selected, provide a rationale for the selected remedy, and establish performance standards or goals for the site or the operable unit under consideration. The ROD provides a plan for site design and remediation, and documents the extent of human health or environmental risks posed by the site or operable unit. It also serves as legal certification that the remedy was selected in accordance with the requirements of CERCLA and the NCP. The ROD is one of the most important documents in the remedy selection process, because it documents all activities prior to selection of a remedy and provides a conceptual plan for activities subsequent to the ROD. The ROD contains the following three sections:

- **Declaration** — The declaration is the formal statement that makes the ROD legal and binding. It is signed by the EPA Regional Administrator or Assistant Administrator of OSWER that identifies the selected remedy and indicates

that the selection was carried out in accordance with the statutory and regulatory requirements of the Superfund program.

- **Decision Summary** — The decision summary provides an overview of the problems and risks posed by the conditions at the site, the remedial action alternatives, and the analysis of those alternatives. The decision summary also explains the rationale for the selection and how the selected remedy satisfies statutory requirements and performance goals.
- **Responsiveness Summary** — The responsiveness summary addresses comments received from the public. This document provides the lead agency with information about community preferences regarding both the remedial alternatives and general comments about the site. It also demonstrates to members of the public how their comments were taken into account as an integral part of the decision making process.

After completion of the ROD, a notice should be published that the ROD is final and available to the public in the Administrative Record before commencing the remedial action. The ROD must document any significant changes from the proposed plan and responses to all significant comments that were received during the public comment period. The ROD is signed after closure of the public comment period and once all significant comments or issues are addressed.

If public comments result in changes to the remedy, the changes should be clearly documented in the section of the ROD describing significant changes from the Proposed Plan. If a fundamental change to the remedy is made between the Proposed Plan and the ROD (such as changing a treatment remedy to a containment remedy), then an amended Proposed Plan should be issued and a new public comment period must be opened.

After the ROD is signed, new information may come to light that may alter the effectiveness, extent, or implementation of the remedial action. Three types of changes may occur:

- Non-significant or minor
- Significant
- Fundamental.

Non-significant changes are characterized as minor changes that do not overly affect the scope or the objective of the selected remedy. They should be noted in the post-decision document file, or may be documented in an optional Remedial Design Fact Sheet.

A significant change does not modify the overall remedy but could alter a component of the remedy. If a significant change to a component of the remedy is needed, then an Explanation of Significant Differences (ESD) must be developed, approved, and released to the public.

At the other end of the spectrum, a reconsideration of the hazardous waste management approach subsequent to the ROD is considered a fundamental change to the remedy and requires a ROD Amendment. When such fundamental changes are made to a remedy, a repetition of the ROD process, including issuance of a revised Proposed Plan and a new public comment period, is necessary.

A ROD amendment looks very similar to an initial ROD and should include a Responsiveness Summary; however, the introductory sections (such as the site history, community relations, and site risks) do not need to be readdressed. Rather, the focus of the discussion should be on the rationale for the ROD Amendment, evaluating the alternatives in terms of the nine criteria, and provided assurances that the new proposed remedy satisfies the statutory requirements.

The ROD does more than just document the remedy selected at one site. It provides an accounting of what remedies have been selected given a set of conditions. EPA has developed a detailed data base of RODs, called the Records of Decision System. (RODS). The RODS data base serves as a central information base to promote national consistency between RODs. Sites with similar conditions may use related RODs to help select remedies.

Once the course of action has been selected and approved, it is time to design the remedial action and carry it out. The last phases of the remedial process are remedial design (RD), remedial action (RA), and operation and maintenance (O&M). In these phases, EPA oversees design of the remedy, construction and implementation of the remedy, determination that the remedy is complete, and that the State continues operation and maintenance, if required.

REMEDIAL DESIGN

Remedial design is an engineering phase in which technical drawings and specifications are developed for the selected remedy as documented in the ROD. In a Fund-lead, EPA assigns RD and RA work to either the Alternative Remedial Contract Strategy (ARCS) contractors, the U.S. Corps of Engineers (USACE), or the U.S. Bureau of Reclamation (BuRec), depending on the type of remedy and the estimated cost of the project. In a State-lead, State, local agencies, or Indian Tribes may manage the design and construction of those Superfund actions for which they have lead responsibility. Responsible parties may conduct RD/RA activities following court orders or settlement agreements. The RD phase includes the following five general components:

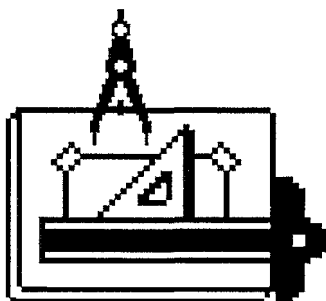

- 1. Remedial design project plan**— This entails assigning lead agency and support agency roles and responsibilities, selecting a remedial design firm, and preparing the Statement of Work (SOW). When EPA is leading a response action, a Superfund State Contract (SSC), that assures the transfer of cost-sharing funds, is entered into between a State or Indian Tribe and EPA. It can also be used to specify required State involvement during a political subdivision-lead response. Also, EPA may sign an IAG with the USACE or BuRec for contractor procurement and oversight activities. In addition to a SSC and an IAG, EPA may also enter into a settlement agreement or use court orders to compel a responsible party to complete the cleanup. If the State has lead responsibility, a Cooperative Agreement would be signed specifying EPA and State responsibilities.

Following the determination of roles and responsibilities, an Architect Engineer (A/E) firm is selected to develop the remedial design along with other related design plans. A SOW also is developed. The SOW requires the A/E firm to design the remedy selected in the ROD and to develop other plans such as an O&M plan, quality assurance

project plan (QAPP), and a health and safety plan. The SOW may also include a schedule and budget for the A/E firm to follow.

- 2. Develop, review, and approve design** — This ensures that the design is progressing in a manner consistent with the ROD and existing environmental and construction standards. EPA and the State review all of the design products. The primary responsibility for design review and approval depends on who has the primary lead for the RD (e.g., Federal, State, or PRP).
- 3. Obtain permits, approvals, and site access** — This confirms that all the necessary documentation is included in the RD package. As in the review component, the lead design party is responsible for obtaining all of the necessary permits and approvals for off-site actions. On-site CERCLA activities do not require a permit. In the case of site access, the State has responsibility for obtaining site access agreements for Federal- and State-lead design, while the responsible party is responsible for obtaining access for Enforcement-lead design. All parties must be informed when the necessary permits, approvals, and site access agreements such as non-environmental construction permits, right-of-way approvals, and environmental permits from facilities receiving materials taken off-site have been obtained.
- 4. Conduct community relations activities** — This keeps the community informed of all ongoing activities at the site. Specifically, the community relations plan should be revised to reflect citizen concerns and involvement at this stage of the process and a public notice and updated fact sheet should be prepared at the completion of the engineering design. Public meetings may be held to inform the public of the technical status, if necessary. The RPM, working with the Community Relations Coordinator, is responsible for site community relations activities.
- 5. Develop cost estimates for construction** — This develops a cost estimate for constructing and implementing the remedial design. The project cost estimates should be as accurate and as complete as possible. However, the estimates become more refined as the design progresses from the ROD to the preliminary design to the final design.

Following completion and final approval of the RD package, the actual implementation of the remedial action begins.

REMEDIAL ACTION

The **remedial action** process consists of executing a cost-share agreement between EPA and the State (unless Enforcement-lead), procuring a cleanup contractor, ensuring that the contractor implements the remedies according to the RD, and preparing the site for long-term monitoring and maintenance. Specifically, the RA process can be divided into the following three steps:

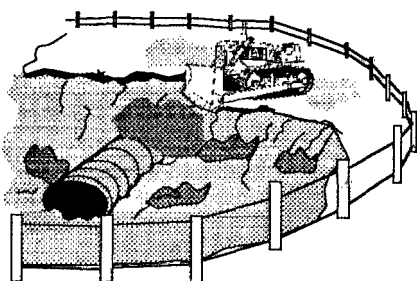

- 1. Remedial action project planning** — This entails updating the SSC, CA, or IAG, procuring a contractor to implement the design, and preparing the SOW. Specifically, agreements between the State or other agencies may need to reflect changes in the remedy based on the design or a change between EPA, State, or Enforcement-lead. A contractor to construct and implement the design must be procured, and finally a SOW requiring the contractor to follow the design and schedule from the remedial design phase is necessary.
- 2. Implement, monitor, and oversee action** — This ensures that the remedy is constructed and compliance with legal, contractual, environmental, and health and safety requirements is verified. The contractor constructs the remedy in accordance with the remedial design plans. During the construction process, the lead and support agencies conduct periodic inspections and reviews to ensure the project is on time and within budget.
- 3. Complete pre-final inspection, final inspection, closeout and transition to O&M** — This serves to ensure that the overall project is complete and consistent with all legal or contractual agreements. The purpose of the pre-final inspection is to determine whether the remedy has been constructed in accordance with physical plans and specifications. Some minor fine-tuning of the remedy maybe necessary at this point. After a pre-final inspection and approval of a preliminary operable unit Closeout Report, the operable unit maybe categorized in CERCLIS as “construction complete.” An interim operable unit Closeout Report for long-term remedial actions, documents that a remedy is operational and functional. After the final operable unit Closeout Report is submitted, O&M activities should commence for that operable unit.

The site Closeout Report, produced after the final inspection, documents how an implementable remedy(ies) satisfies site completion requirements. After the site Closeout Report is submitted, all O&M activities should have been commenced. O&M activities are those measures required to maintain the effectiveness of response actions. The process for deleting a site from the NPL is appropriate when EPA and the State agree that all necessary response measures have been taken (or none are necessary).

A remedy becomes "operational and functional" either one year after construction is complete, or when EPA and the State determined jointly that the remedy is functioning properly and is performing as designed. The date certified in the final inspection /certification report that the project is operational and functional and in accordance with the contract documents, is the date when O&M, the last phase of the remedial process, commences.

OPERATION & MAINTENANCE

The State or PRP assumes responsibility for the **operation and maintenance**, which may include such activities as ground water and air monitoring, inspection and maintenance of the treatment equipment remaining on site, and maintenance of any security measures or institutional controls. Although the State or PRP is responsible for implementing O&M, EPA carefully monitors the site through 5-year reviews to ensure that the remedy at each site remains protective of human health and the environment.

SECTION VIII

STATE AND INDIAN TRIBAL INVOLVEMENT

- **OVERVIEW**
- **STATUTORY AND REGULATORY FRAMEWORK**
 - S CERCLA
 - S Definitions of Response roles
 - S State Assurances
 - S NCP and Subpart O
- **MECHANISMS FOR PROMOTING INVOLVEMENT**
- **STATE AND INDIAN TRIBAL ACCOMPLISHMENTS**

SECTION VII STATE AND INDIAN TRIBAL INVOLVEMENT

OVERVIEW



Since the enactment of CERCLA, **States** have actively participated in the Superfund program, and the extent of their involvement has grown over time. CERCLA authorizes and encourages EPA to allow States and political subdivisions, such as county governments, which have the necessary technical and management expertise, to act as lead agency for many of the cleanup efforts. CERCLA also requires EPA to coordinate with States when EPA leads the site response.

State involvement in Superfund was strengthened and broadened when CERCLA was amended by SARA. SARA encourages State involvement by specifying the points at which State participation is required. SARA also outlines minimum requirements for involving States in virtually every phase of Superfund decision-making. As a result, States participate in enforcement, removal actions, site assessment, and remedial activities, including remedial investigations (RIs), feasibility studies (FSs), remedial designs (RDs), and remedial actions (RAs). Also, States are responsible for providing certain assurances, including sharing in the cost of designated cleanup activities as a pre-condition to EPA spending Trust Fund monies for remedial actions; identifying State ARARs; and funding and conducting O&M at a site.

When States acts as the lead agency, EPA participates as a support agency but is ultimately responsible for the remedy selection and the efficiency of the cleanup. SARA extends this EPA/State interaction to **Indian Tribes**, for most purposes. EPA must treat eligible Indian Tribal governments essentially the same as States. These Indian Tribes may either lead a response or provide support when EPA leads the response activities. To be eligible for this role, an Indian Tribe must:

- Be Federally recognized
- Have a Tribal governing body that promotes health, safety, and welfare of the affected population and protects the environment within a defined geographical area
- Have jurisdiction over a site in CERCLIS, or have jurisdiction over a site that is proposed or listed on the National Priorities List (NPL), at which a Trust Fund-financed response is contemplated

- Have a financial management system capable of tracking Superfund expenses by site, activity, and operable unit, as applicable, according to object class, as determined through an EPA “Pre-award Financial Systems Review.”

The Bureau of Indian Affairs (BIA) establishes criteria to determine whether an Indian Tribe is Federally recognized and publishes a list of these Tribes in the Federal Register annually.

Local governments also play an important role during a Superfund cleanup. Localities may lead a response action and often provide important public safety services during emergencies. For these services, localities may receive some financial assistance under the Local Government Reimbursement (LGR) program. The LGR program is intended to ease the financial burden on local governments from conducting temporary emergency services in response to a hazardous substance threat. The program offers assistance of up to \$25,000 per response directly to local governments.

STATUTORY AND REGULATORY FRAMEWORK

Congress and EPA have developed a comprehensive framework of laws and regulations to guide State, political subdivision, and Indian Tribal involvement. CERCLA, as amended by SARA, created the original framework for State and Indian Tribal involvement. In 1990, this framework was completed with revisions to the National Oil and Hazardous Substances Pollution Contingency Plan (NCP) and with EPA's development of the Superfund Administrative Regulation, 40 CFR Part 35, Subpart O.

CERCLA

CERCLA authorizes the Federal government to assume lead responsibility for hazardous substance response activities at a site, or to transfer the necessary funds and management responsibility to a State, to a political subdivision of a State, or to a Federally-recognized Indian Tribe. The NCP is the regulatory framework for Superfund response, regardless of who is the lead agency.

Definitions of Response Roles

EPA and the State hold meetings to decide who will take the lead responsibility for each site.

For a Fund-lead response, the State, a political subdivision thereof, or an Indian Tribe may function as a support agency. As a support agency, a State, political subdivision, or Indian

Tribe may hold some key responsibilities and perform specific parts of the cleanup, but does not take on the major portion of tasks for the response.

For a State-lead response, EPA takes on a secondary role and functions as the support agency. However, EPA must approve all response selection decisions. A **State-lead** response can mean one of three things:

- The State is overseeing a PRP cleanup
- The State is carrying out most aspects of the cleanup, but the response is Trust Fund-financed
- The State is given lead responsibility and is financing the response.

Also, a political subdivision may hold primary responsibility for carrying out the response. In this case, the response is called a **political subdivision-lead** response. For a political subdivision-lead response, the State and EPA function as a support agency.

Regardless of who has the lead role at a site, EPA still maintains responsibility for assuring the protectiveness of the remedy. Also, EPA is responsible for assuring that the remedy is in compliance with Federal and State environmental laws and regulations.

State Assurances

There are five assurances a State must make before a Trust Fund-financed remedial action may take place, whether EPA or State-lead. CERCLA section 104 requires that a State must assure it will:

- **Pay for part of the cleanup costs** — A State is required to pay 10 percent of the costs of a remedial action if the site was privately operated at the time of the hazardous substance release. A State is required to pay 50 percent or more of all cleanup costs if the State or locality operated the site when hazardous substances were disposed there. For example, if a State-operated municipal landfill is found leaking hazardous substances, the State would be required to provide at least half the cost of a Trust Fund- financed response. Political subdivisions may provide the cost share, but the State must assure payment in case of default.

- **Ensure adequate off-site storage, disposal, or treatment of hazardous substances removed from a site as a part of the remedy** — The State must assure that off-site facilities are available for storage, disposal, or treatment.
- **Assume responsibility for all Operations and Maintenance (O&M) activities for a remedial action or removal** — The State assumes ultimate responsibility for performing O&M of the selected remedy, even though a political subdivision may manage the actual O&M. These activities include activities that are required to maintain the effectiveness of the remedy.
- **Document State's commitment to accept interest in real estate that may need to be acquired for a Superfund response** — If EPA determines that an interest in real estate must be acquired in order to conduct a remedial response, EPA must first obtain the agreement of the State in which the interest is located, to acquire and hold the necessary interest as well as maintain any institutional controls established during cleanup. The State must agree to accept transfer of the acquired interest on or before completion of the response action.
- **Have capacity for disposal or treatment of all hazardous wastes expected to be generated within the State during the next 20 years** — This assurance consists of the State's capacity assurance plan (CAP), which must be approved by EPA before Trust Fund-financed remedial actions take place in the State. The CAP must be resubmitted for each group of wastes the State needs to treat or dispose. The plan must show that the State has the capacity to treat or dispose of the wastes generated within the State for the next 20 years.

Federally recognized Indian Tribes are not required to provide these CERCLA assurances. In many cases, EPA provides the required assurances for Indian Tribes. If, however, EPA determines that an interest in real estate must be acquired in order to conduct the site-specific response action, Indian Tribes are required to provide the real property assurance.

The mechanisms for obtaining these assurances include Cooperative Agreements for State-lead responses, or

Superfund State Contracts for EPA-lead or political subdivision-lead responses. These mechanisms are explained in greater detail below.

NCP and Subpart O

The **NCP** and the Superfund Administrative Regulation, 40 CFR Part 35, Subpart O (**Subpart OO**) also contribute to the legislative and regulatory framework of State and Indian Tribal involvement. Subpart F of the NCP, State Involvement, requires EPA to solicit and encourage substantial and meaningful involvement by each State and Indian Tribe. Subpart F also regulates EPA and State interaction to ensure consistent communication and coordination. Subpart O defines how EPA can transfer funds for site response to States, political subdivisions, and Indian Tribes to support the development of their Superfund programs' goals and maintain their ability to respond to hazardous waste threats.

MECHANISMS FOR PROMOTING INVOLVEMENT



EPA has defined four ways to involve States, Indian Tribes, and political subdivisions in Superfund:

- ! **Cooperative Agreements (CAS)** — Cooperative Agreements transfer funds from EPA to States, political subdivisions, or Indian Tribes to lead site-specific responses or to cover the costs of their participation in EPA-lead or other CERCLA activities. Also, a CA is the legally-binding document to obtain required State cost shares and CERCLA section 104 assurances when a State or Indian Tribe leads a remedial action.
- ! **Superfund State Contract (SSC)** — An SSC is a joint, legally-binding agreement between a State or Indian Tribe and EPA that assures the transfer of cost-sharing funds when EPA is leading a Superfund response action. The SSC documents that the State or Indian Tribe meets all required assurances under CERCLA. It also can be used to specify required State involvement during a political subdivision-lead response.
- ! **Core Program Cooperative Agreements** — EPA created Core Program Cooperative Agreements to provide administrative Superfund program support funds to States and Indian Tribes. Core Program funding defrays the cost of essential State and Indian Tribe activities that cannot be accounted for on a site-specific basis, but are essential to an active role in CERCLA implementation. For example,

States and Indian Tribes have used Core Program Cooperative Agreements to pay for administrative and clerical salaries, computer resources, program management, recordkeeping, and training.

- **Superfund Memoranda of Agreement (SMOAs)** — EPA developed SMOAs to define the working relationship between EPA and a State or Indian Tribe. A SMOA is an optional, non-binding document that specifies the procedures that EPA and a State or Indian Tribe will use to implement CERCLA and its guiding regulations. These procedures then serve as the basis for developing and coordinating a site-specific Cooperative Agreement or SSC.

In addition to these four types of agreements defined in the NCP, there may be other site-specific agreements between a State and EPA. These agreements may be established to define EPA and State roles where a State is given the lead but there is no Trust Fund-financing.

CERCLA section 121 (f) (1) mandates that the State has the opportunity for “substantial and meaningful” involvement in the selection of remedial actions. The NCP specifically addresses the State’s role in remedy selection. For sites where Trust Fund monies or EPA enforcement authority is used, EPA retains final remedy selection authority, but there is an opportunity for State concurrence, on remedy selection. For sites where States use their own enforcement authority and sources of funding other than the Trust Fund, and the State has been designated as the lead, the State may select a remedy without EPA concurrence. However, the State will still need EPA certification to delete the site from the NPL.

STATE AND INDIAN TRIBAL ACCOMPLISHMENTS

During the first ten years of the Superfund program, and especially since the passage of SARA, States and, more recently, Indian Tribal governments and political subdivisions, have assumed greater and greater responsibility for Superfund response. Since 1990, the number of State-lead removal, remedial, and site assessment activities has increased significantly.

The number of State-lead activities is greatest in the site assessment program. In the first ten years of the Superfund program, States have completed nearly 60 percent of all PAs

conducted, and more than 32 percent of all SIs. Two Indian Tribal governments also have been awarded Cooperative Agreements to conduct site assessment activities.

States have made an equally significant contribution to remedial activities at hazardous waste sites. And, the number of ongoing activities led by States has grown steadily over time. This increase suggests a strong State commitment toward long-term cleanup activities. In addition, four Indian Tribes have been awarded Cooperative Agreements to conduct support activities during EPA-lead remedial response activities.

Core Program funds have enhanced State and Indian Tribal Superfund capabilities. The Core Program began in FY 87 with three pilot States. As of 1991, 44 States, the Territory of Puerto Rico, and three Indian Tribal governments are active in the program. The Core Program will assist each State, Territory, and Indian Tribal government in determining the long-term roles they will take in Superfund.

SECTION IX

FEDERAL FACILITIES

- **OVERVIEW**
- **CERCLA REQUIREMENTS**
 - S Federal Agency Hazardous Waste Compliance Docket
 - S National Priorities List
 - S Interagency Agreements
- **FEDERAL AGENCY RESPONSE AUTHORITY UNDER CERCLA**

OVERVIEW

**Office of
Federal Facilities
Enforcement (OFFE)**

At EPA, the Office of Federal Facilities Enforcement (OFFE), within the Office of Enforcement, is responsible for ensuring that Federal facilities comply with CERCLA requirements. The primary goals of OFFE are to assist EPA Regions to reach and implement CERCLA cleanup agreements at National Priorities List (NPL) sites on Federal facilities and to ensure compliance with hazardous substance laws in a nationally consistent manner. OFFE develops guidance and policy for Federal facility compliance, assists in resolving issues that arise in negotiations with Federal facilities, tracks ongoing negotiations, and supports enforcement actions.

The Federal facilities that have been identified that require investigation and possible remediation under CERCLA range in size from hundreds of acres to tens of thousands of acres, and many contain multiple contamination areas. Federal facilities that require investigation are those that manage hazardous substances or may have potential hazardous substance problems. The Departments of Defense (DoD), Interior (DOI), and Energy (DOE) account for about 84 percent of the Federal sites that require investigation.

Hazardous substance contamination at Federal facilities may result from such activities as:

- Manufacturing, testing, loading, and packaging weapons
- Maintaining and repairing aircraft and vehicles
- Plating metal
- Producing, processing, and recovering nuclear materials.

Types of hazardous substances disposed of include explosives, solvents and cleaning agents, paints, heavy metals, pesticides, waste oil, and various organics. At DOE facilities, disposal of high- and low-level radioactive and mixed hazardous and radioactive substances is a common problem. Past disposal practices at Federal facilities include disposal in unlined pits, drainage ditches, holding ponds, drying beds, and landfills; discharge on the ground; and burning.

CERCLA REQUIREMENTS

CERCLA devotes a special section to Federal facilities, **section 120**. Section 120(a) states that Federal departments, agencies, and instrumentalities are subject to CERCLA just

like nongovernment entities, including CERCLA's liability provisions. Pertinent guidelines, rules, regulations, and criteria apply in the same manner and to the same extent, with the exception of requirements pertaining to bonding, insurance, and financial responsibility.

Federal Agency Hazardous Waste Compliance Docket

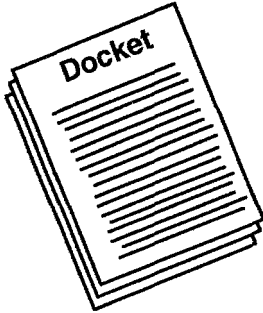

Section 120 of CERCLA establishes special requirements and timetables regarding Federal facilities. For example, section 120(c) requires establishment by EPA of a **Federal Agency Hazardous Waste Compliance Docket** that lists Federal facilities that have reported managing hazardous substances or releases of hazardous substances. Based on information submitted under CERCLA and other environmental statutes, the docket identifies the universe of Federal facilities to be evaluated for possible NPL listing. The docket is updated biannually and includes information on releases of reportable quantities of hazardous substances under section 103 of CERCLA.

The docket is available for public inspection at EPA Regional Offices. Each Regional docket contains the documents submitted under the reporting provisions described above, and any relevant correspondence, for each facility in that Region. A complete national index is maintained at EPA Headquarters.

Once a Federal facility is listed on the docket, CERCLA requires that a preliminary assessment (PA) be conducted within 18 months. The statute requires EPA to ensure that a PA is conducted. EPA requires the Federal agency to complete a PA and, if necessary, a site inspection (SI) within 18 months. The authority to conduct PAs is delegated to Federal agencies by Executive Order 12580.

National Priorities List

Following the PA and SI, EPA applies the Hazard Ranking System (HRS), where appropriate, to list Federal facility sites on the **NPL**. However, inclusion on the NPL does not mean Superfund monies are available for cleanup, as is the case with nonfederal sites. Section 111(e) of CERCLA specifies that the Trust Fund is not available for most remedial actions at Federal facilities. Still, NPL listing of Federal facilities serves the purpose of alerting the public and providing information concerning risks to public health or the environment from the site. In addition, NPL listing assists Federal agencies to set cleanup priorities, brings additional

statutory deadlines to bear on response actions, and gives EPA an important oversight role, including the authority to determine what the remedy will be.

If a Federal facility is included on the NPL, CERCLA mandates that the facility begin a remedial investigation/feasibility study (RI/FS), in consultation with EPA and the State, within 6 months of listing. EPA and the State must publish an enforceable timetable and deadlines for RI/FS completion, and EPA must review the RI/FS when completed.

Interagency Agreements

Section 120 of CERCLA requires the Federal facility to enter into an **interagency agreement (IAG)** with EPA for the remedial action. The IAG provides the technical, legal and management framework under which the response at the Federal facility is conducted. The IAG specifies who is responsible for what and when. The IAG lists the Federal facility's responsibilities as lead agency. However, EPA retains authority over remedy selection.

IAGs are enforceable through CERCLA's section 310 citizen suit provision. In addition, section 122(l) specifically authorizes imposition of civil penalties for failure or refusal to comply with an IAG.

According to CERCLA, the IAG is to be entered into within 180 days of EPA's review of the RI/FS. But many times the negotiations are conducted when the Federal facility is promulgated to the NPL.

EPA policy, reflected in the model IAGs developed with DoD and DOE, is to enter into an IAG before, rather than after, the RI/FS is conducted. This provides for early input by EPA and the State into the RI/FS and remedy selection process. EPA policy is to try to have three-party IAGs, with the State joining EPA and the Federal facility as an active partner and signatory. However, if the State is not amenable to participating in the IAG, a two-party IAG may be established between EPA and the Federal facility.

CERCLA requires cleanup, defined as continuous on-site presence, to begin at a Federal facility no later than 15 months after RI/FS completion. The RI/FS is complete when the Record of Decision (ROD) is signed. In their annual budget

submissions, Federal agencies must include a review of alternative funding that might be used to provide for cleanup costs. The annual budget submission also has to include a statement on the hazards posed to public health and welfare, and the environment, as well as the consequences of failure to begin and complete remedial action. In addition, each Federal agency participating in the CERCLA program must submit an annual report to Congress. This report must describe the Federal agency's progress in such areas as reaching IAGs and conducting RI/FSs and cleanups.

**FEDERAL AGENCY
RESPONSE AUTHORITY
UNDER CERCLA**

Section 120 and Executive Order 12580 delegates CERCLA section 104 response authority to Federal agencies for releases on their facilities or originating from their facilities. Such response authority must be exercised in accordance with section 120. This allows the EPA Administrator to make the final decision on remedy selection should EPA and a Federal agency disagree. Under Executive Order 12580, EPA is given the response authority under CERCLA for emergency removals at Federal facilities owned or operated by agencies other than DoD and DOE.

Federal agencies have their own environmental programs. DoD established the Installation Restoration Program (IRP) in 1975. Under the IRP, each service operates a program to identify and evaluate past waste disposal practices at DoD facilities. Studies and remediation are conducted as necessary. Section 211 of CERCLA governs management of the IRP.

DOE initiated an informal program in 1984 to identify, evaluate, and remediate hazardous substance contamination at DOE facilities. DOE is developing a formal response program.

SECTION X

COMMUNITY RELATIONS/PUBLIC PARTICIPATION

- **OVERVIEW**
- **COMMUNITY RELATIONS REQUIREMENTS**
 - S Community Relations Plan
 - S Information Repositories/Administrative Record
 - S Proposed Plan
 - S Public Comment Period
 - S Respond to Comments
 - S Remedial Design Fact Sheet
- **OTHER REQUIREMENTS AND ACTIVITIES**
 - S Technical Assistance Grants

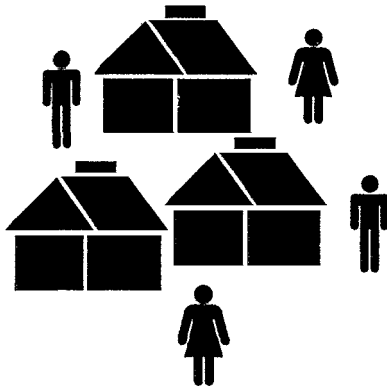
OVERVIEW

The public is deeply concerned about, and often fearful of the potential impacts of hazardous substances on their health and safety. Many hazardous substance releases occur in populated areas, and the surrounding communities are often concerned about the effects these hazardous substances may have on their health and the health of their children. The Superfund program recognizes the public's rights and interest in hazardous waste management, and makes conscious attempts to include communities in the decision-making process.

The action-oriented nature of the Superfund program promotes a comprehensive, community relations program designed to promote communication among all parties involved in, or affected by, the Superfund process. The overall goal of public participation is to build trust and credibility, and to keep emotions, human energy, and conflicts focused on substantive issues and solutions. Public participation provides an opportunity for all interested parties to become informed and involved, and to influence response action development and implementation. EPA has found that actively involved community members improve Superfund response decisions. An involved community better understands the Superfund process and contributes valuable site information and history.

The community relations initiative has grown and matured since Superfund's inception in 1980. From the beginning, EPA has recognized the importance of community input and involvement in the cleanup of hazardous waste sites. In the early days of the program, community relations activities generally occurred on an informal, site-specific basis with no required activities. As the Superfund program evolved, EPA began to formulate community relations policy statements and develop guidance. The 1982 NCP required community relations activities for all remedial cleanups and for removals lasting more than 120 days. In 1986, SARA made community relations a legislated requirement and in 1990, the *Management I Review of the Superfund Program (90-Day Study)* made recommendations to further improve the community relations program.

Throughout the years, one aspect of the program has been retained — EPA still conducts community relations activities on a site-specific basis. Although the overall program has many required activities, each activity is tailored to meet the needs of the specific community. These community relations programs strive to address the most important issues to the public, the level of concern, and the economic and social structure of the community.

In general, the Superfund community relations program is designed to encourage communication with affected citizens and public participation in the decision-making process. The program has three main objectives:

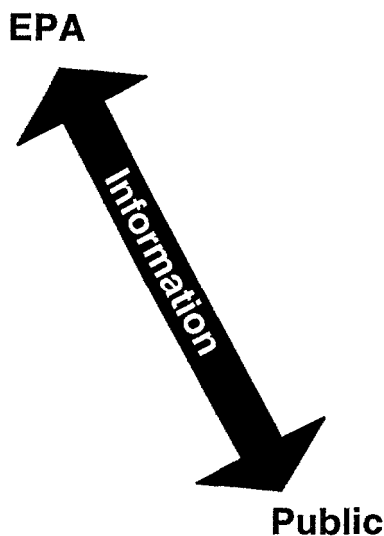

- Keep the public informed of planned or ongoing actions, the nature of the environmental problem, the threats it may pose, the responses under consideration, and the progress being made.
- Give the public the opportunity to comment on and provide input to technical decisions.
- Focus and resolve conflict. Conflict may be unavoidable in some circumstances, but it can be constructive if it brings into the open alternative viewpoints.

This open communication better enables EPA to respond to community concerns during each step of the cleanup process.

COMMUNITY RELATIONS REQUIREMENTS

EPA conducts over a dozen community relations activities in conjunction with response action decisions (generally at NPL sites). While similar, public participation activities may vary during removal actions and the remedial process, but generally include the following major activities:

- Site-specific Community Relations Plan (CRP)
- Information Repositories /Administrative Record
- Explanation of Planned Response Activities
- Public Comment Periods
- Response to Comments
- Remedial Design Fact Sheet.

Each activity contributes to the community's involvement in the Superfund process.

Community Relations Plan

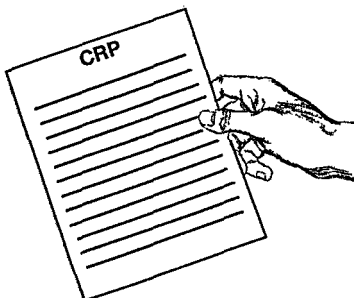

A site-specific **Community Relations Plan (CRP)** is the foundation for EPA's community relations efforts during a site cleanup. The CRP outlines continued interaction with the community based on past public interest and concerns. This plan:

- Lists various ways to encourage effective, two-way communication between the community and EPA
- Identifies locations for information repositories and public meetings
- Summarizes the conditions and history of a site, and provides a chronology of past community involvement.

To develop a CRP EPA must conduct personal interviews with individuals who represent the community, i.e., concerned residents, State and local officials, business representatives, educators, and representatives of environmental and other community organizations.

The CRP synthesizes the regulatory, technical, and community interest aspects of a site. The CRP benefits both EPA and the community by reflecting past events and current concerns. Activities specifically designed to satisfy the informational needs of both EPA and the community are also outlined in the CRP. The CRP is both a tool and a measure of EPA accountability to the community.

Later in the Superfund remedial cleanup process, EPA revises the CRP to ensure that new community concerns and questions are addressed. This revision is made after EPA has selected a remedy based on community input, and before the remedial design is under way.

Information Repositories/ Administrative Record

As a part of every CRP, EPA plans an **information repository**. EPA is required to set up this file of information related to the site in an accessible, convenient location in the community, typically a library or town hall. Examples of documents in the information repository include site work plans, the CRP, the remedial investigation/feasibility study (RI/FS), Health Assessment, Proposed Plan, sampling reports, fact sheets, and other special reports developed for the site. EPA continually updates the repository and ensures that the

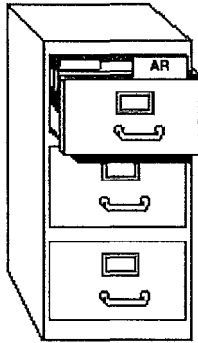

facility housing the file has copying capabilities. EPA may establish more than one information repository in the site community. The number of repositories depends on the site and community circumstances, such as size, population distribution, and the nature and degree of community interest.

In addition, at least one information repository in the community must contain EPAs **Administrative Record** file for the site. The administrative record file consists of the technical documents that form the basis for all decisions concerning the site. It also is an element in the public participation process, because it may be reviewed by the public and contains all public comments on the proposed response alternatives and EPA's response to those comments.

Since the administrative record contains all technical documents and comments, it is the primary document available for judicial review when a site remedy is challenged. An administrative record is required by law for all removal and remedial actions taken under CERCLA authority. The administrative record file is kept both at the selected information repository and in the Regional Office.

Proposed Plan

During the remedial process, EPA prepares a **Proposed Plan**, after the RI/FS is completed and a preferred cleanup alternative has been recommended. This plan summarizes:

- Environmental conditions at the site
- Alternative cleanup technologies considered for addressing the contamination
- The remedy proposed to be selected by EPA
- EPA's reasons for preferring that remedy over the others.

Because the Proposed Plan is a public participation document, EPA composes it for a lay audience. Typically, this is done through a Proposed Plan fact sheet, which EPA distributes to individuals on its site mailing list and any other interested parties. In addition, EPA publishes a notice regarding the availability of the Proposed Plan in a local newspaper of general circulation. This notice summarizes the plan and announces the public comment period.

Public Comment Period

Before EPA selects the remedy in the remedial process, EPA provides community members a **public comment period** and an opportunity for a public meeting to discuss the plan. Citizens are entitled to a minimum of 30 days to review and comment on the Proposed Plan and other potential remedial alternatives. Comments to the plan may be made orally or in writing. EPA is required to extend the comment period, for a minimum of 30 additional days, upon receipt of a timely request to do so.

EPA routinely holds public meetings on Proposed Plans to ensure that site community members have had an opportunity to voice questions, opinions or concerns about a proposed remedy. For removal actions, if time permits, public comment periods and meetings are held on the action memorandum and engineering evaluation/cost analysis (EE/CA) if available. Finally, as required by EPA Guidance and the NCP, EPA hires court reporters for these public meetings, to provide verbatim transcripts to document public concerns and comments. In some cases, the public's involvement has changed the course of Superfund projects.

Respond to Comments

At the conclusion of the public comment period, EPA prepares a summary of all questions and comments received from the public and EPA's responses to these inquiries and comments. This summary of inquiries and responses, entitled the **Responsiveness Summary**, is included in EPA's Record of Decision (ROD) for the site. For removal actions, a written response to significant comments on the action memorandum and EE/CA is included in the administrative record file. This summary should be written in clear, easy-to-understand language, so that the public can find EPA's response to their comments.

If EPA significantly changes its selected remedy as a result of its review of the RI/FS and comments, and the changes could not reasonably have been anticipated by the commenters, EPA publishes a revised Proposed Plan explaining the differences to the public before completing the ROD. In such cases, EPA extends or renews the public comment period. Then EPA publishes a notice of the ROD. The notice informs the public of the final decision and the availability of the ROD for public review.

Remedial Design Fact Sheet

Upon selection of the remedial action remedy, EPA prepares and distributes a **remedial design fact sheet** to the local community. The fact sheet explains the technical concepts in the remedial design, using non-technical terms whenever possible.

OTHER REQUIREMENTS AND ACTIVITIES

In addition to all of the above specific requirements, the Administrative Procedure Act and SARA impose public participation requirements when EPA proposes to do any of the following: delete sites from the NPL; add sites to the NPL; or include a specific site in a special research and design program known as the Superfund Innovative Technology Evaluation (SITE) Program. If EPA proposes to add or delete a site from the NPL, the Agency publishes a notice in the Federal Register to inform the public and solicit comments. In addition, EPA holds a public comment period on proposals to add sites to the SITE program.

Beyond specific requirements, EPA Regional Offices conduct a broad spectrum of activities at sites throughout the RI/FS process. Depending upon the nature of the site and the specific needs of the community, EPA activities may include producing fact sheets, conducting school programs, operating a telephone hot line, holding media briefings, updating key local leaders, preparing videotape productions, and facilitating the formation of local task forces.

Technical Assistance Grants

To help communities understand the technical aspects of hazardous wastes, EPA created the **Technical Assistance Grant (TAG)** program. Established by Congress in 1986, the TAG program helps ensure that affected individuals are well informed about the conditions and activities at Superfund sites in their communities. The program provides grants for groups of individuals to hire independent technical advisors who can help them understand technical information, findings, and recommendations related to a site.

The TAG program is intended to provide grants to groups for up to a three-year period. When the period is over, groups who have monies remaining (and work at the site is still underway) may apply for a continuation of the grant. However, because cleanup of a hazardous waste site is complex and may take longer than three years, groups sometimes spend their monies before cleanup is complete. If this is the case, groups may apply for a waiver, and if approved, receive an additional \$50,000.

Groups eligible to receive TAGs are groups of individuals who live near the site and whose health, economic well-being, or enjoyment of the environment is directly threatened. Such groups may be existing citizens' associations, environmental or health advocacy or similar organizations, or coalitions of such groups formed to deal with community concerns about a hazardous waste site and its impact on the surrounding area. Grant funds may be used to hire technical advisors to increase citizen understanding of information that already exists about the site, or that is developed during the Superfund cleanup process. Grant monies are often used to pay technical advisors to review site-related documents, meet with the recipient group to explain technical information, interpret technical information for the community, and travel to meetings and hearings related to the site.

In conclusion, Superfund participants at the Federal, State, and local levels acknowledge the importance of public participation in the Superfund program. Because it is such an integral part of all cleanup operations, EPA is constantly striving to improve its communications with the public.

Over the past 10 years EPA has gained experience about the nature of public involvement in hazardous waste issues and, in turn, about the most helpful approaches to public participation. EPA has learned, for example, that its decision-making ability is enhanced by actively soliciting comments and information from the public. Experience has shown that the earlier EPA establishes a working relationship with citizens near a site, the greater chance there is for trust and confidence to develop between the parties. EPA also has found that communities often are able to provide valuable information on local history, citizen involvement, and site conditions. Establishing a dialogue between EPA staff and citizens, allows both the public and EPA access to important information, and enables EPA to respond to community needs.

SECTION XI

MANAGEMENT AND TECHNICAL INFRASTRUCTURE

- **OVERVIEW**
- **MANAGEMENT INFRASTRUCTURE**
 - Management Review of the Superfund Program/*90-Day Study*
 - Long-Term Contracting Strategy
 - Delivery of Analytical Services
 - Superfund 30-Day Study
 - Management Information Systems and Operating Guidelines
- **SCIENTIFIC AND TECHNICAL INFRASTRUCTURE**
 - Technical Information Systems
 - Technology Development Programs
- **PROGRAM-WIDE MEASUREMENT OF PROGRESS**
 - Measures of Progress

OVERVIEW

The complexity and volume of Superfund activity requires a normal set of systems and procedures to manage the cleanup process, measure program progress, establish short-term and long-term goals, and encourage the development and use of cleanup technologies. To serve this purpose, the Superfund program established a program management and technical infrastructure. This infrastructure includes systems for planning and tracking expenditures at thousands of hazardous waste sites nationwide, scientific and engineering support to provide state-of-the-art solutions to hazardous waste problems, and a program-wide measurement and improvement process.

**MANAGEMENT
INFRASTRUCTURE**

CERCLA, for the first time, required EPA to step beyond its traditional regulatory role and provided response authority to clean up hazardous waste sites. As a result, EPA designed, developed, and put in place a network of policies, procedures and contracting mechanisms to achieve the ambitious goals of the program. This network is being continually refined to provide the policy, information management, and accounting tools necessary for effective program implementation. Several top-level studies of program operations have led the Superfund program to the management practices it follows today.

***Management Review of the
Superfund Program/90 Day
Study***

In 1989, the EPA Administrator committed to undertake a comprehensive study of the Superfund program. That study is entitled the *Management Review of the Superfund Program*, and is known as the **90-Day Study**. The review resulted in more than 50 recommendations to address the fundamental management challenges facing the program. These include:

- Reducing risks from a growing list of sites that present health, safety, and environmental problems
- Making defensible cleanup decisions, sometimes without complete knowledge of environmental and health risks
- Maximizing the use of treatment technologies, while recognizing that many of the technologies are new and untested in the field
- Making efficient use of limited resources.

The *90-Day Study* also outlined eight strategic goals for the second decade of the Superfund program:

“90-Day Study”

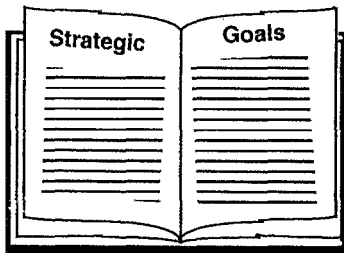

- **Control acute threats immediately** — EPA will quickly evaluate and appropriately respond to ensure protection from immediate threats to people and the environment.
- **Emphasize enforcement** — EPA will use its authorities to encourage or compel PRPs to conduct site work.
- **Address worst sites/worst problems first** — After resolving the immediate threat, EPA will begin remedial work to address the highest priority problems.
- **Monitor and maintain sites over the long-term** — EPA will monitor Superfund sites over the long-term to ensure the remedy remains protective.
- **Develop and use new technologies** — EPA will develop, demonstrate, and use new or innovative technologies to achieve final site cleanups, to the maximum extent practical.
- **Improve efficiency of program operations** — EPA will pursue a “one Superfund” approach to site cleanup activity and enforcement against polluters (i.e., the removal, remedial, and enforcement programs will work together as “one”).
- **Encourage full public participation** — EPA will increase the role of citizens in Superfund decision-making and encourage clear and consistent two-way communication.
- **Foster cooperation with other Federal and State agencies** — EPA will work with State agencies, natural resource trustees, Indian Tribal governments, and other Federal agencies to ensure an effective and cooperative relationship.

Acting on the recommendations outlined in the *90-Day Study*, EPA is making continual improvements to the Superfund program and has achieved significant progress to address immediate threats, move ahead on permanent remedies, apply “enforcement first” principles, and encourage innovative technologies.

Long-Term Contracting Strategy

Another significant accomplishment of the *90-Day Study* is the development of a **Long-Term Contracting Strategy** for Superfund field operations. EPA analyzed the long-term contracting needs of the program, and designed a portfolio of Superfund contracts to meet those needs over the second 10 years of the program. The strategy was completed in September 1990.

The Long-Term Contracting Strategy is built on several key principles. The strategy: (1) supports an integrated “one program” approach to enforcement and site cleanup; (2) enhances the competitive environment by reducing the size of contracts and creating more opportunities for small and disadvantaged businesses; and, (3) provides mechanisms for greater flexibility and improved oversight and cost management by giving the Regions full responsibility for the contracts.

The principal components of the Long-Term Contracting Strategy are:

- **Enforcement Contract Support** — Enforcement Support Contracts will provide support for specific enforcement related activities (e.g., litigation support, PRP searches). These contracts will be competed and managed on a Regional basis. Enforcement oversight activities will be moved to remedial contracts.
- **Regional Management Contract Support** — Regional Management Contracts will provide support for administrative and information management activities in the Regions. These contracts will be competed and managed on a Regional basis.
- **Removal Contract Support** — Technical Assistance Team (TAT) Contracts provide support for removal technical assistance and will be competed and managed on a Regional basis. Time-critical removal and remedial response activities will be combined, competed, and managed on a Regional basis. Non-time-critical removal actions will be combined with remedial contracts and conducted by Response Action Contractors.

- **Analytical Contract Support** — Environmental Services Assistance Team Contracts will continue to provide environmental services support and will be competed and managed on a Regional basis.
- **Preremedial (Site Assessment) Contract Support** — TAT contracts will provide support for preremedial activities, which will combine dedicated team programs of preremedial support and removal technical assistance into one integrated program. In the interim, Alternative Remedial Contracting Strategy (ARCS) contracts will provide preremedial support.
- **Remedial Contract Support**— Response Action Contracts provide support for all remedial activities and will be managed on a Regional basis. Existing ARCS contracts will be used to perform all enforcement oversight activities, conduct non-time-critical removal actions, and provide interim preremedial support.
- **Site Specific Contracts** — Site Specific Contracts provide support tailored to the needs of a specific site or types of sites, contaminants, or activities.
- **Transportation and Disposal Contract Support** — A transportation and disposal broker will provide assistance to resolve technical difficulties in making arrangements for transportation and disposal of hazardous substances.

The EPA Administrator commissioned a task force in June 1991 to take a hard look at Superfund contracting. The task force identified several areas for improvement. EPA will: (1) establish a concrete goal of reducing program management costs to less than 20 percent of total contract costs; (2) take steps to terminate contractors that perform poorly; and (3) implement a program of timely audits for all ARCS contractors.

Delivery of Analytical Services

In April 1991, EPA's Office of Emergency and Remedial Response (OERR) established a task force to develop a Superfund long-term strategy for the **delivery of analytical services** (e.g., lab analyses, data validation, QA plans) by September 1992. The project is focused on three primary areas:

- The long-term programmatic needs for analytical services
- The roles and responsibilities of private parties, EPA contractors, and EPA staff in addressing these needs
- The alternative delivery mechanisms for analytical services.

The task force is comprised of members from all ten EPA Regions, representing the Waste Management, Environmental Services, and Management Divisions. The Headquarters participants include representatives from OERR, and the Offices of Waste Programs Enforcement (OWPE), Administration and Resources Management (OARM), Research and Development (ORD), and Regional Operations (ORO). A steering committee of eight senior representatives from the Regions and eight senior representatives from Headquarters oversees the project and communicates issues and results to senior management.

Superfund 30-Day Study

In 1991, EPA conducted the **Superfund 30-Day Study** to find ways to invigorate the Superfund program and improve the pace of cleanups. The overall goal of this study was to reduce the current period of 7 to 10 years from site discovery to completion of remedial construction, by about 2 to 2.5 years. In this effort, EPA is doing the following:

- Setting aggressive cleanup targets
- Streamlining the Superfund process
- Elevating site-specific issues for timely resolution
- Accelerating private party cleanups
- Improving public awareness of Superfund successes
- Standardizing remedies and investigation procedures
- Prioritizing risk reduction.

The Superfund program has a new position of National Superfund Director, charged with overseeing all Superfund procurements and budgeting and implementing measures to improve contracting and accelerate cleanups. This Director is supported by a 20 to 30 person troubleshooting team designed to serve as a “strategic nerve center” for Superfund, providing an early warning system for identifying problems and solutions.

The continuous improvement and analysis of Superfund progress is complemented by ongoing improvements in formal management information systems, technology programs, and accomplishments reporting.

***Management Information
Systems and Operating
Guidelines***

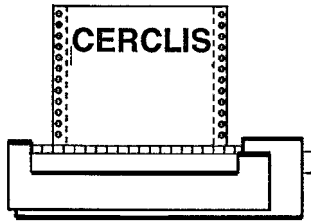

Superfund's management systems are designed to coordinate the large sums of money and thousands of tasks involved with simultaneously conducting and overseeing hundreds of projects across the nation. The primary system is CERCLIS. This data base tracks all reported sites as potential National Priorities List (NPL) sites, the activity at those sites, and the funding related to each site. Once a site is entered into CERCLIS, it remains there regardless of the type of action taken. Ownership of the data in CERCLIS resides with the Regions and sponsorship is the responsibility of the Program Offices. CERCLIS is available on-line at Headquarters and on the Regional Local Area Network.

EPA has formulated procedures to be followed by EPA staff in Headquarters, the 10 Regional EPA offices, other Federal agencies, State agencies, contractors, and private parties for implementing the Superfund program and responding to questions from the public. These procedures are explained in directives, guidances, and fact sheets describing each step in the technically complex process of identifying, investigating, and cleaning up sites. These Superfund documents are available to EPA staff through the Superfund Document Information Center and to all others through the National Technical Information Service (NTIS). In addition, EPA maintains a toll-free hotline with staff available to respond to Superfund related questions from EPA and the public at 1-800-424-9346.

**SCIENTIFIC AND TECHNICAL
INFRASTRUCTURE**

Finding solutions to the problems associated with hazardous substances involves the combination of empirical results of field sampling with theoretical models by hundreds of environmental scientists. These results and models are ever-changing and constantly being updated. For example, the limits for detecting contaminants in soil or water are constantly changing and the task of estimating the degree to which human health and the environment are endangered by hazardous substances is becoming increasingly complex. Finally, there is a great deal of uncertainty about the engineering techniques and equipment used in handling,

containing, treating, and disposing of hazardous substances. EPA frequently develops guidance documents and supports numerous research programs to address these problems.

Technical Information Systems

A number of technical information systems have been developed and enhanced to support the Superfund program. These systems store up-to-date information on a wide range of topics from the potential risk imposed by chemicals to an information clearinghouse for performance data on treatment technologies. Some of these new technical data systems are:

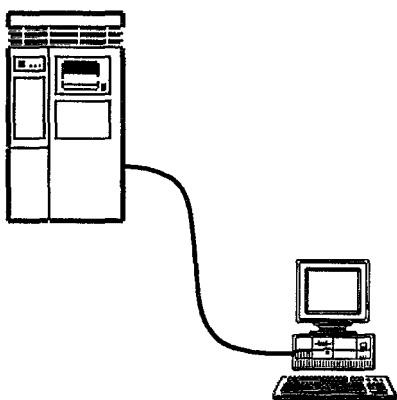

- **Alternative Treatment Technology Information Center (ATTIC)** — a computer-based, key word search data base that will contain data and abstracts from EPA treatability studies, demonstrations and remedial actions, and State activities.
- **Emergency Response Notification System (ERNS)** — a computerized system to record and retrieve all notification related data from releases of hazardous substances, waste, oil, or other substances. This system maintains data on the frequency, amounts, and types of substances released regionally and nationally.
- **Integrated Risk Information System (IRIS)** - a system that stores EPA accepted toxicological information about a specific chemical.

IRIS and ERNS are available by on-line computer for remote information retrieval. ATTIC is accessible by both telephone and on-line computer.

Technology Development Programs

One of the major programs to address technology development needs is the Superfund Innovative Technology Evaluation (SITE) program. SITE provides the treatment technologies necessary to address new contamination scenarios. The SITE program is really three related programs: the Demonstration Program, the Emerging Technologies Program, and the Measurement and Monitoring Technologies Program.

The **Demonstration Program** is designed to generate engineering and cost data on selected, innovative technologies. The major focus of the SITE program has been on the

Demonstration Program. In this program, technology developers are responsible for demonstrating their innovative systems at selected sites, while EPA is responsible for sampling, analyzing, and evaluating all test results. The information gathered during the demonstrations is used in combination with other data as a basis for selecting technologies appropriate for cleaning up Superfund sites.

The **Emerging Technologies Program** provides 2-year funding to developers of emerging technologies to support bench-scale and pilot testing of innovative treatment technologies.

The **Monitoring and Measurement Technologies Program** supports the development and demonstration of innovative field-ready technologies that detect, monitor, or measure hazardous substances in the air, surface water, soil, subsurface, waste materials, and biological tissues.

PROGRAM-WIDE MEASUREMENT OF PROGRESS

The principles of **Total Quality Management (TQM)** are being applied as a means for ensuring the continuing evolution and development of the performance of Superfund. Steps are being taken to: (1) clearly identify Superfund's customers and their requirements; (2) produce error-free work; (3) continuously improve operations; and (4) effectively manage the workload by preventing waste and inefficiency. Evidence of these steps includes the creation of a Quality Action Team to examine ways to improve the quality of risk assessments for Superfund projects. Superfund is always looking for ways to improve the process while reducing unnecessary paperwork.

Measures of Progress

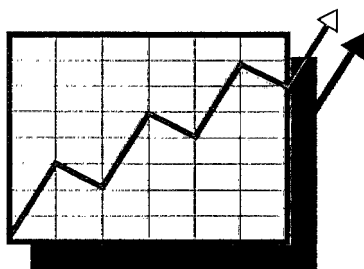

One of the real problems facing the Superfund program has been measurement of program progress and communication of program success to the public. Superfund has made many gains in terms of protecting human health and the environment. However, to date, little attention has been paid to any measurements other than the number of sites deleted from the NPL. In the first 10 years of the program, thousands of unmeasured actions have been taken to protect people and the environment from the hazards these sites pose. Some of these actions are responses to emergencies such as hazardous substance spills, while others are long term actions to clean up contamination that may have accumulated for decades.

To measure the progress accomplished, EPA has now developed several environmental indicators of progress. These indicators relate to the overall goals of the Superfund program:

- Control of immediate threats to human health, welfare and the environment (make sites safer)
- Achievement of long-term site cleanup goals (make sites clean)
- Removal of contamination from the environment (treat hazardous waste).

EPA uses these new indicators to demonstrate to the public, in understandable terms, the progress made by Superfund. In general, the measures indicate how many sites are free from immediate threats (i.e., safer), are cleaner, and have permanent solutions. Development of these means of measuring progress is vital to determine the overall goals and accomplishments of the Superfund program. A new model that incorporates alternative measures of progress is further discussed in Section XIV: Future Directions of the Superfund Program.

To obtain further information regarding Superfund program priorities and objectives from fiscal year to fiscal year, refer to the Superfund Program Management Manual, 1991, Vol. I, EPA/540/P-91/004A.

SECTION XII

APPLICABLE OR RELEVANT AND APPROPRIATE REQUIREMENTS

- **OVERVIEW**
- **DEFINITION OF ARARs**
 - S Applicable Requirements
 - S Relevant and Appropriate Requirements
 - S “To Be Considered” Materials
- **SCOPE OF ARARs**
 - S ARARs and Remedial Actions
 - S ARARs and Removal Actions
 - S Substantive Requirements
 - S Administrative Requirements
 - S On-Site vs. Off-Site
- **TYPES OF ARARs**
- **TIMING OF COMPLIANCE**
- **POINT OF COMPLIANCE**
- **ARAR WAIVERS**
 - S Interim Measure
 - S Greater Risk to Health and the Environment
 - S Technical Impracticability
 - S Equivalent Standard of Performance
 - S Inconsistent Application of State Requirements
 - S Fund-Balancing

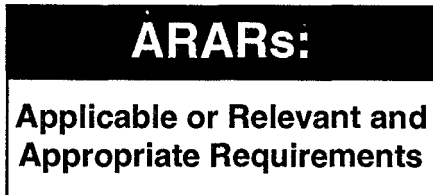
OVERVIEW

Compliance with the applicable or relevant and appropriate requirements (ARARs) of other environmental laws is a cornerstone of CERCLA. To avoid simply displacing the contamination at a site from one medium (i.e., air, soil, water) into another, identification of ARARs is the major prerequisite for setting cleanup goals, selecting the remedy, and determining how to implement the remedy while assuring protection of human health and the environment. However, the diverse characteristics of CERCLA sites preclude the development of prescribed ARARs, so that, by necessity, identification of ARARs is conducted on a site-by-site basis.

DEFINITION OF ARARs

Congress provided a statutory basis for ARARs in SARA, which added section 121, "Cleanup Standards," to CERCLA. Section 121(d) mandates the degree of on-site cleanup that sites must achieve. According to this section, response actions conducted under sections 104 and 106 of CERCLA must at least attain (or justify a waiver of) all ARARs of other Federal environmental laws, more stringent State environmental laws, and State facility-siting laws. ARARs include:

- Any standard, requirement, criterion, or limitation under any Federal environmental law, such as the Toxic Substances Control Act (TSCA), the Safe Drinking Water Act (SDWA), the Clean Air Act (CAA), the Marine Protection, Research, and Sanctuaries Act (MPRSA), and the Resource Conservation and Recovery Act (RCRA)
- Any promulgated standard, requirement, criterion, or limitation under a State environmental or facility-siting law, including those contained in EPA-approved programs, that has been identified by the State to EPA in a timely manner.

SARA modified the waivers listed in the 1985 National Oil and Hazardous Substances Pollution Contingency Plan (NCP) and established State standards as ARARs if they have been promulgated, are enforceable, and are more stringent than similar Federal standards. In March 1990, EPA promulgated revisions to the NCP that incorporate the ARARs provisions contained in SARA. For the purposes of section 121(d), the

term “State” includes the Territories and Possessions of the United States, as well as the Federally- recognized Indian Tribes.

Applicable Requirements

ARARs consist of two sets of requirements, those that are applicable and those that are relevant and appropriate. Applicable requirements are those substantive standards that specifically address the situation at a CERCLA site; however, an applicable requirement need not have been promulgated specifically to apply to CERCLA sites. Decision-makers have minimal discretion in determining whether a requirement is legally applicable; if an objective comparison of the jurisdictional prerequisites of the requirement to the circumstances at the site shows a direct correspondence, the requirement is applicable. These prerequisites consist of identifying: (1) who is subject to the statute or regulation; (2) what types of substances or activities fall under the authority of the statute or regulation; (3) what is the time period for which the statute or regulation is in effect; and, (4) what types of activities does the statute or regulation require, limit, or prohibit. If a requirement is not legally applicable, a decision-maker must exercise considerable best professional judgment to determine whether it is relevant and appropriate under the circumstances of the release of contamination.

Relevant and Appropriate Requirements

The second set of requirements is relevant and appropriate requirements. The procedure for determining whether a requirement is relevant and appropriate is a two-step process. First, to determine relevance, the decision-maker must determine whether the requirement addresses problems or situations sufficiently similar to the circumstances of the proposed response action. Second, for appropriateness, the determination must be made as to whether the requirement would also be well-suited to the conditions of the site. There are eight comparisons which must be made, where pertinent, in determining relevance and appropriateness when responding under CERCLA:

- The respective purposes of the requirement and of the response action
- The medium regulated or affected by the requirement and the medium contaminated or affected at the site
- The substances regulated by the requirement and those found at the site

- The activities regulated by the requirement and the remedial action contemplated at the site
- Any variances, waivers, or exemptions of the requirement and their availability for the circumstances at the site
- The type of site regulated and affected by the release or action
- The type and size of the structure or facility regulated, and those affected by the release or contemplated by the action
- Any consideration of use or potential use of affected resources, in the requirement and at the site.

Note that in some cases, only a portion of a requirement will be both relevant and appropriate. Once a requirement is deemed relevant and appropriate, it must be attained (or waived). If a requirement is not both relevant and appropriate, it is not an ARAR.

***“To Be Considered” Materials
(TBCS)***

Many Federal and State environmental and public health agencies develop criteria, advisories, guidance, and proposed standards that are not legally enforceable but contain information that would be helpful in carrying out, or in determining the level of protectiveness of, selected remedies. In other words, “to be considered” materials (TBCs) are meant to complement the use of ARARs, not to compete with or replace them. Because TBCs are not ARARs, their identification and use are not mandatory.

In conjunction with the completion of the baseline risk assessment, where no ARARs address a particular situation, or the existing ARARs do not ensure sufficient protectiveness, the TBC advisories, criteria, or guidelines should be used to set cleanup targets. TBCs may be invaluable in deciding how to carry out a particular remedy. Many ARARs have broad performance criteria but do not provide specific instructions for implementation. Often those instructions are contained in supplemental program guidance.

SCOPE OF ARARs

ARARs are identified on a site-by-site basis for all on-site response actions where CERCLA authority is the basis for cleanup. The lead agency as well as the supporting agencies must identify and communicate information about potential ARARs to each other. For Trust Fund-financed CERCLA sites

and for those actions taken pursuant to CERCLA section 106 authority, EPA makes the final decision on ARARs. Cleanups at all CERCLA sites, regardless of which agency has the lead, must comply with (or waive) ARARs.

ARARs and Remedial Actions

It is important to recognize that CERCLA addresses two types of response actions, remedial and removal. All **remedial actions** taken under CERCLA must meet ARARs at the completion of the action (or justify a waiver). Further, the NCP requires remedies to attain or waive ARARs during the course of a remedial action. Moreover, where an ARAR requires a permit, CERCLA provides for the on-site work to comply with only the substantive, but not the administrative, requirements of the ARAR. Complying with ARARs both during the implementation and upon completion of an action helps the lead agency define the ways in which the activity can be carried out in a manner that is protective of human health and the environment.

ARARs and Removal Actions

Although CERCLA specifies ARARs only for on-site remedial actions, the NCP requires **removal actions** to attain ARARs to the extent practicable, considering the urgency of the situation at the site. Regulations under other environmental and public health laws may help determine the appropriate manner in which to proceed with a removal action. Removal actions generally focus on the stabilization of a release or threat of release and mitigation of near-term threats.

EPA has adopted two criteria for determining practicability for removal sites:

- The urgency of the situation
- The scope of the removal action.

Where the conditions at a site constrain or preclude efforts to identify and attain ARARs, the documentation of these conditions will be considered sufficient basis for justifying not attaining all ARARs. For example, because of the urgency at the site, an On-Scene Coordinator (OSC) may have to undertake an immediate response to remove or stabilize leaking drums near a residential area in order to prevent a fire or explosion. Also, where a removal action is for a limited purpose (e.g., to address a direct-contact threat), attainment of soil cleanup ARARs that would require a more extensive response action may be beyond the scope of the removal action, and, therefore, impracticable.

Requirements are only ARARs when they pertain to the specific action(s) undertaken on-site. For example, if the removal of drums also included excavating highly contaminated soil, the removal action would not have to meet standards for other media, if those standards might be ARARs for a final remedial action at the site.

Substantive Requirements

Just as CERCLA addresses two types of response actions, it also addresses two classes of requirements: substantive and administrative.

Although a **substantive requirement** usually specifies a level or standard of control, it could also provide performance criteria or location restrictions. In addition, monitoring requirements are considered substantive, for the purpose of ascertaining whether the levels and limitations set in the decision document have been attained.

Remedies conducted entirely on-site must comply with only the substantive provisions of requirements that are ARARs. Also, CERCLA section 121(e)(1) specifically exempts on-site actions from obtaining Federal, State, and local permits, although the substantive provisions of permitting programs that are ARARs must be met (or waived). This permit exemption applies to all on-site CERCLA activities both before and after the remedy has been selected. The exemption applies regardless of whether the lead agency is EPA, another Federal agency, or a State, when the activity (which could be an investigation or a section 106 action) is conducted entirely on-site.

Administrative Requirements

Administrative requirements consist of those mechanisms that facilitate the implementation of the substantive requirements of statutes or regulations. In other words, requirements that in and of themselves do not define a level or standard of control are considered administrative (e.g., approval by or consultation with administrative bodies, application for permits, documentation, reporting, and record keeping). However, EPA recognizes the benefits of consultation, coordination, reporting, and other such practices and strongly encourages decision-makers to engage in these activities, as well.

Exemption from administrative requirements for on-site actions promotes expeditious response to protect human health and the environment from actual and potential threats

at CERCLA sites. Congress recognized that subjecting CERCLA decision-making to the myriad of overlapping and potentially disparate administrative requirements of other Federal and State laws might significantly lengthen response time. Moreover, CERCLA has its own set of procedures designed to promote the type of consultation and public review generally achieved during the permit application process. These procedures address the remedy selection process and also provide opportunities for systematic State and community involvement.

On-Site vs. Off-Site

As with actions and requirements, it is important to note that CERCLA also addresses two types of cleanup locations, on-site and off-site. According to the NCP, the term “**on-site**” means the geographical (or, as the NCP calls it, the “areal”) extent of the contamination and all suitable areas in very close proximity to the contamination that are necessary for implementation of the response action. Using this definition, EPA includes both the surface area and the air above the site, as well as the hydrogeologic contamination beneath the surface, including the ground water plume.

This broad definition of “on-site” provides EPA with flexibility in situations where implementation necessitates activities that are conducted “**off-site**,” or outside of the waste area itself and/or in areas not contiguous to the site. Cleanup actions that fall within this definition must meet the substantive but not the administrative requirements. On the other hand, response actions carried out off-site are simply subject to applicable law, including administrative requirements and any specified procedures for obtaining permits. For off-site actions, no analysis of relevant and appropriate requirements is needed and no statutory ARARs waivers are available.

TYPES OF ARARs

Any substantive environmental (or State facility-siting) requirement has the potential to be an ARAR. Due to the complexity of the universe of such requirements, EPA divides ARARs into three categories to facilitate identification:

- **Chemical-specific ARARs** usually are either health- or risk-based numerical values or methodologies that establish the acceptable amount or concentration of a chemical that may remain in or be discharged to the environment. Where more than one requirement addressing a contaminant is determined to be an ARAR, the requirement that should be used is the one that is the

most stringent. Note, however, that in some cases, a less stringent requirement is more well-suited to the circumstances at a site, such that a more stringent requirement will not be deemed to be relevant and appropriate under the circumstances.

- **Location-specific ARARs** generally restrict certain activities or limit concentrations of hazardous substances solely because of geographical or land use concerns. Requirements addressing wetlands, historic places, floodplains, or sensitive ecosystems and habitats are potential location-specific ARARs.
- **Action-specific ARARs** usually are restrictions on the conduct of certain activities or the operation of certain technologies at a particular site. Regulations that dictate the design, construction, and operating characteristics of incinerators, air stripping units, or a landfill construction are examples of action-specific ARARs.

Some ARARs might not fit neatly into any one of these categories while others may qualify for more than one. Even if an ARAR does not fall into any such category, it may still be an ARAR if it meets all the jurisdictional definitions for a requirement to be an ARAR.

TIMING OF COMPLIANCE

Although CERCLA stipulates only that ARARs must be met at the completion of the remedial action, the NCP requires attainment of ARARs during remediation, as well. During the course of the Remedial Design/Remedial Action (RD/ RA), the lead agency is responsible for ensuring that all Federal and State ARARs identified for the action are being met, unless a waiver has been invoked.

CERCLA provides a number of waivers, including one for interim actions, as long as the final action attains the waived standard. If there is doubt about whether an ARAR can be met during the remedial activity, but no doubt that it will be met at completion of the remedy, this waiver can be considered.

POINTS OF COMPLIANCE

Points of compliance for attaining precise remediation levels are established on a site-specific basis. There are some general policies for establishing points of compliance. For ground water, remediation levels should generally be attained throughout the contaminated plume, or beyond the edge of the waste management area when waste is left in place, as in

a closed, capped landfill. EPA does acknowledge, however, that in specific ground water cases, an alternative point of compliance might be more protective of public health and the environment. For air, the selected levels should be established for the maximum exposed individual, considering reasonably expected use of the site and surrounding area. For surface waters, the selected levels should be attained at the point, or points, where the release enters the surface waters.

ARAR WAIVERS

In certain instances, EPA may choose an on-site cleanup method which does not meet an ARAR. CERCLA section 121(d) provides that, under certain circumstances, an ARAR may be waived. The six statutory waivers are:

- Interim Measure
- Greater Risk to Health and the Environment
- Technical Impracticability
- Equivalent Standard of Performance
- Inconsistent Application of State Requirements
- Fund-Balancing.

These waivers can be used for both remedial and removal actions, but they apply only to on-site activities and to compliance with ARARs. A waiver must be invoked for each ARAR that the remedy will not attain. Other statutory requirements, such as the one mandating remedies that are protective of human health and the environment, may not be waived.

Interim Measure

The **Interim Measure waiver** is for a temporary action that does not attain all ARARs, but will be followed by measures that will complete the cleanup and attain all ARARs. The interim action should neither exacerbate the problems at the site nor interfere with the final remedy. An Interim Measure waiver may be useful when a final remedy is divided into several smaller actions or operable units.

Greater Risk to Health and the Environment

The **Greater Risk to Health and the Environment waiver** is for situations in which compliance with an ARAR would result in greater risk than noncompliance. Before invoking this waiver, site decision-makers need to consider the magnitude, duration, and reversibility of adverse impacts resulting from compliance with such an ARAR, as compared

with the protectiveness of a remedy that is not in compliance. This waiver can only be invoked for ARARs that would cause greater risk.

Technical Impracticability

The **Technical Impracticability waiver** may be used when compliance with an ARAR is infeasible from an engineering perspective. The term "impracticable" means an unfavorable balance of engineering feasibility and reliability. Because engineering is ultimately limited by costs, estimated costs are a legitimate—but not the primary—consideration in determining feasibility.

Equivalent Standard of Performance

The **Equivalent Standard of Performance waiver** may be invoked when an ARAR can be equaled or exceeded through an alternate cleanup method, which should achieve contaminant limitations and demonstrate reliability and effectiveness as a system. Although this permits flexibility in choosing a cleanup technology, it must not reduce the standard of performance or the required level of control.

Inconsistent Application of State Requirements

CERCLA allows the selection of a remedy that does not comply with a State ARAR when that State has applied that particular requirement inconsistently. The waiver is designed to avoid unreasonable restrictions at CERCLA sites if those State requirements have not been applied to non-CERCLA sites. Because EPA presumes State standards are applied consistently, the State does not have to document consistency unless requested to do so. The invocation of this waiver may be prompted by variably applied or inconsistently enforced State standards. A single example of the State's having chosen or approved a less stringent standard than that specified in the ARAR may be sufficient justification for the waiver.

Fund-Balancing

A **Fund-Balancing waiver** may be applied when the cost of attaining an ARAR for a solely Trust Fund-financed action does not represent a reasonable balance between the availability of Trust Fund monies for remedies at other sites and the degree of protection anticipated at the site. In other words, the waiver may be invoked when meeting an ARAR would entail such cost in relation to the added degree of protection or reduction of risk that remedial action at other sites might be jeopardized. However, as with all waivers, the selected remedy still must comply with the statutory requirement for protectiveness.

It is EPA policy to routinely consider, though not necessarily to invoke, this waiver when the cost of attaining an ARAR is four times the national average cost of an operable unit. For example, the threshold amount in 1991 was approximately \$57.6 million. The waiver may be considered at funding levels below the threshold, as well.

SECTION XIII

CERCLA's RELATIONSHIP TO OTHER LEGISLATION

- **OVERVIEW**
- **RESOURCE CONSERVATION AND RECOVERY ACT (RCRA)**
 - S How RCRA and CERCLA Overlap
 - S Imminent Hazards Under RCRA and CERCLA
 - S How RCRA and CERCLA Differ
 - S How RCRA Regulations Affect CERCLA Remedy Selection
 - S RCRA Corrective Action vs. CERCLA Response
- **OIL POLLUTION ACT OF 1990 (OPA)**
 - S How OPA and CERCLA Interact
- **CLEAN WATER ACT (CWA)**
 - S How the CWA and CERCLA Interact
- **CLEAN AIR ACT (CAA)**
 - S How the CAA and CERCLA Interact
- **SAFE DRINKING WATER ACT (SDWA)**
 - S How the SDWA and CERCLA Interact
- **TOXIC SUBSTANCES CONTROL ACT (TSCA)**
 - S How TSCA and CERCLA Interact
- **HAZARDOUS MATERIALS TRANSPORTATION UNIFORM SAFETY ACT OF 1990 (HMTUSA)**
 - S How HMTUSA and CERCLA Interact

OVERVIEW

EPA's role is to protect human health and the environment. Many environmental laws have been enacted to address releases, or threats of releases, of hazardous substances. An understanding of these laws is necessary to see where CERCLA, or the Superfund program, fits into the national environmental protection program established by Congress. Each environmental statute has its own particular focus, whether it is to control the level of pollutants introduced into a single environmental medium (i.e., air, soil, water) or to address a specific area of concern, such as pesticides or waste management.

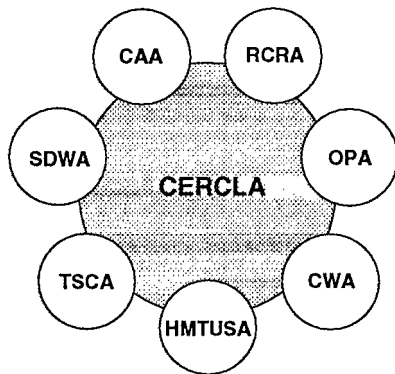

The legislation that serves as the basis for managing hazardous wastes can be divided into three categories:

- C The central statutory authorities are CERCLA and RCRA. The former authorizes cleanup of releases of hazardous substances. The latter creates a management system for current and future hazardous and solid wastes, and authorizes cleanup at hazardous waste management facilities.
- C Several statutes are media-specific and limit the amount of wastes introduced into the air, waterways, oceans, and drinking water.
- C Other statutes directly limit the production of chemical substances and products that may contribute to the nation's waste.

The remainder of this section summarizes each statute and highlights its interaction with the Superfund program.

**RESOURCE CONSERVATION
RECOVERY ACT**

The **Resource Conservation and Recovery Act AND (RCRA)**, an amendment to the Solid Waste Disposal Act, was enacted in 1976 to address a problem of enormous magnitude—how to safely dispose of the huge volumes of hazardous and non-hazardous municipal and industrial waste generated nationwide and to ensure the prevention of future releases. The term "solid waste," by definition, includes traditional

non-hazardous wastes such as municipal refuse and liquid, semi-solid, or gaseous material from industrial, commercial, and mining operations, as well as hazardous waste.

The goals set by RCRA are:

- To protect human health and the environment
- To reduce waste, and conserve energy and natural resources
- To reduce or eliminate the generation of hazardous waste as expeditiously as possible.

RCRA originally provided regulatory authority to address hazardous waste management, but had limited authority to require cleanup. CERCLA was enacted in 1980 to fill the apparent gap in RCRA and the Clean Water Act authority for remedying past mismanagement of hazardous substances.

The 1984 **Hazardous and Solid Waste Amendments (HSWA)** significantly expanded the scope and requirements of RCRA. Regulations have been developed and continue to be expanded based on the HSWA provisions, e.g., Land Disposal Restrictions. In addition, HSWA expanded EPA's authorities to address releases of hazardous waste or hazardous constituents through "corrective actions" or cleanup of wastes released from RCRA hazardous waste facilities. Furthermore, a new program for regulating underground storage tanks was developed under RCRA Subtitle I.

RCRA establishes four distinct, yet interrelated, regulatory programs:

- The **Subtitle D *Solid Waste Management Program*** sets national standards for the management of solid waste (e.g., municipal solid waste landfills)
- The **Subtitle C *Hazardous Waste Management Program*** sets national standards for hazardous waste management, provides for oversight of State implementation of RCRA, and includes corrective action authorities to address releases to the environment
- The **Subtitle I *Underground Storage Tank (UST) Program*** is designed to protect ground water from leaking underground storage tanks

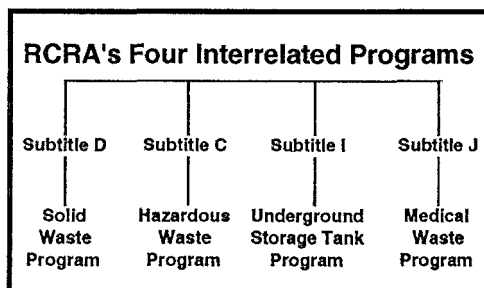

- The **Subtitle J Medical Waste Program** establishes a two-year demonstration program to track medical waste from generation to disposal.

CERCLA is most impacted by RCRA Subtitle C. The RCRA Subtitle C standards for managing hazardous waste affect many CERCLA response decisions, such as which off-site disposal facility to use or which regulatory requirements to consider in implementing on-site response actions.

How RCRA and CERCLA Overlap

RCRA and CERCLA follow roughly parallel procedures in responding to releases. In both, the first step after discovery of a release is an examination of available data to see if an emergency action is warranted. Both programs allow for short-term measures to abate the immediate adverse effects of a release. In RCRA, short-term measures may occur after the investigations. Investigations and formal study of long-term cleanup options are conducted once an emergency has been addressed. When these analyses are completed, both provide the basis for the formal selection of a remedy.

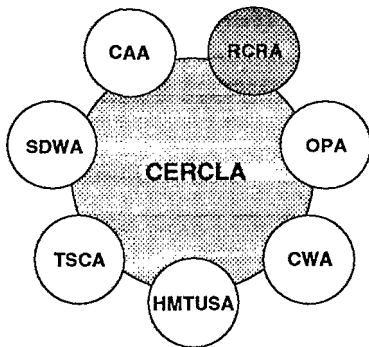

RCRA regulatory requirements are potentially applicable or relevant and appropriate requirements (ARARs) for CERCLA response actions. Thus, many CERCLA response actions must meet the applicable or relevant and appropriate RCRA requirements for on-site actions, unless a waiver is justified under the circumstances. For example, the RCRA Land Disposal Restrictions (LDRs), established under HSWA, maybe applicable to a CERCLA response action involving the placement of hazardous waste in a land disposal unit. In order to determine their applicability, EPA has issued a series of Superfund LDR Guides (LDR Guides 1-8). These guides summarize the major components of the LDRs, such as treatment standards and minimum technical requirements in respect to CERCLA response actions.

In accordance with CERCLA section 121(d)(3) all wastes shipped off-site for treatment, storage, or disposal must be sent to facilities that have been determined by EPA to be "acceptable." In order to be acceptable, a facility cannot have any relevant violations of applicable Federal or State requirements such as RCRA or TSCA and cannot have any relevant releases.

Imminent Hazards Under RCRA and CERCLA

Both CERCLA and RCRA contain provisions that allow EPA to require persons contributing to an **imminent hazard** to take the necessary actions to clean up releases. Under CERCLA section 106, EPA has the authority to abate an imminent or substantial danger to public health or the environment that results from a hazardous substance release. The authority under RCRA section 7003 is essentially the same, except that RCRA's imminent hazard provision addresses non-hazardous as well as hazardous solid waste releases. In an enforcement action, the CERCLA and RCRA imminent hazard provisions may be used in tandem.

How RCRA and CERCLA Differ

RCRA and CERCLA have the common goal to protect human health and the environment from the dangers of hazardous waste. However, as illustrated in Exhibit 7, these statutes address the hazardous waste problem from two fundamentally different approaches:

- RCRA has a largely *regulatory* approach. RCRA regulates the management of wastes from the moment of generation until final disposal, and provides some corrective action authority for investigating and cleaning up contamination at or from RCRA Subtitle C facilities.
- CERCLA has a *response* approach. CERCLA authorizes cleanup actions whenever there has been a breakdown in the waste management system (i.e., a threatening release of a hazardous substance occurs). Also, CERCLA addresses the problems of hazardous waste encountered at inactive or abandoned sites or those resulting from spills that require emergency response.

How RCRA Regulations Affect CERCLA Remedy Selection

In assessing cleanup remedies, EPA takes into account the long-term uncertainties associated with land disposal, long-term maintenance costs, and other considerations.

CERCLA requires that on-site remedies attain any substantive requirements, standards, criteria, or limitations under Federal or more stringent State environmental laws, including RCRA, that are determined to be ARARs (unless site-specific waivers are obtained). Furthermore, the NCP provides that removal actions attain ARARs whenever practicable. This means, for example, that whenever a remedial action involves on-site treatment, storage, or disposal of hazardous waste, the action must meet RCRA's technical standards for treatment, storage, or disposal. EPA interprets

Exhibit 7
RCRA and CERCLA: Different Approaches to a Common Goal

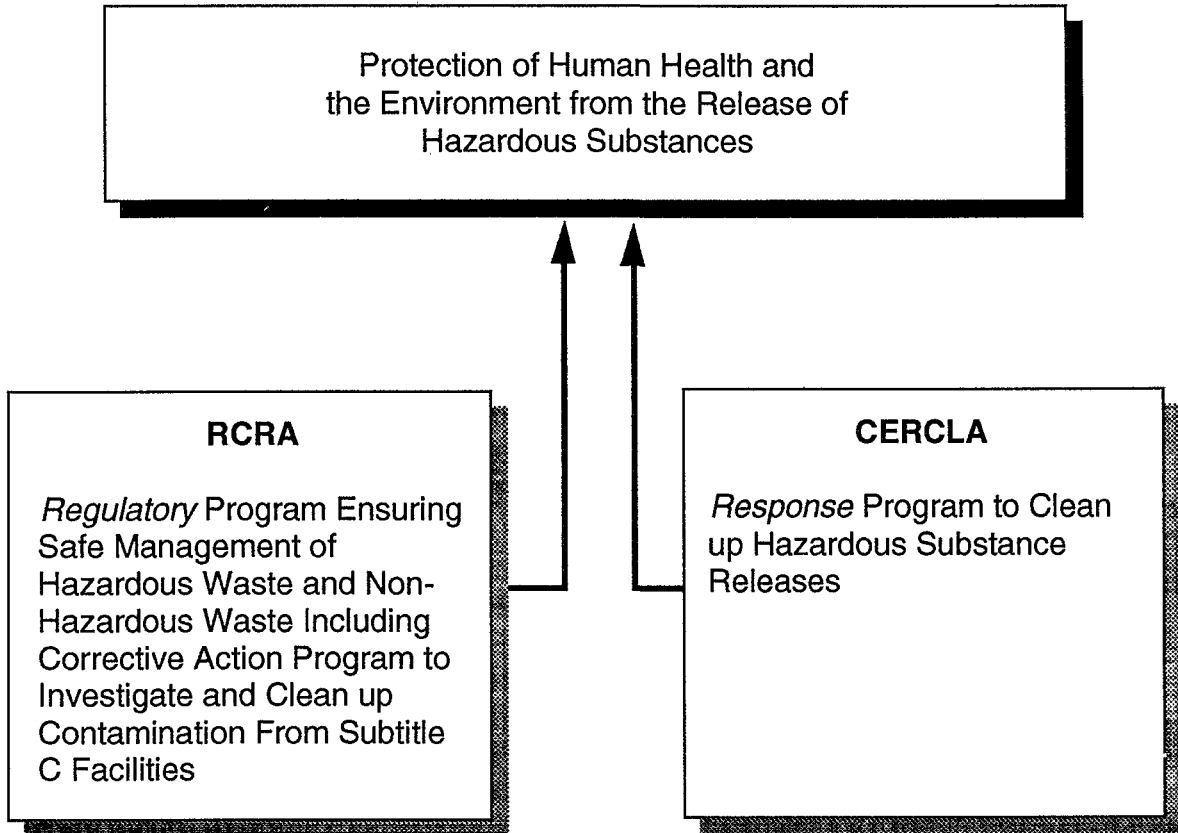

CERCLA to mean that Superfund sites are not required to comply with administrative requirements (e.g., recordkeeping and permits), but that RCRA technical requirements may apply as ARARs. The National Oil and Hazardous Substances Pollution Contingency Plan (NCP), the blueprint for the Superfund program, details the application of ARARs to Superfund remedial actions cited in section 300.435(b)(2).

As noted earlier, once hazardous substances, contaminants, or pollutants are transported from a Superfund site, they are subject to CERCLA's off-site requirement that they go to a facility that EPA has determined acceptable to receive CERCLA wastes. CERCLA wastes that are RCRA hazardous wastes must go to a Subtitle C facility acceptable under the CERCLA off-site policy. Each Regional office has an off-site contact who makes the acceptability determination prior to each offsite shipment of CERCLA wastes.

Finally, as of October 1989, EPA may not take or fund remedial actions in a State unless the State ensures the availability of hazardous waste treatment and disposal capacity. This hazardous waste capacity must be adequate to manage the wastes generated in the State for a period of 20 years and for facilities that are in compliance with RCRA Subtitle C requirements.

***RCRA Corrective Actions vs.
CERCLA Response***

RCRA authorizes EPA to require corrective action (usually under an enforcement order or as part of a permit action) whenever there is, or has been, a release of hazardous waste or constituents. Further, RCRA allows EPA to require corrective action beyond the facility boundary. EPA interprets the term "corrective action" to cover the full range of possible actions, from investigations, studies, and interim measures to full cleanups. Anyone who violates the corrective action order can be fined up to \$25,000 per day of noncompliance and runs the risk of having their operating permit suspended or revoked.

The general distinction between RCRA and CERCLA is as follows: RCRA focuses on waste management and corrective action, while CERCLA focuses on cleanup activities. However, the two programs overlap. For example, RCRA standards are considered ARARs and are central to selecting remedies under CERCLA. Moreover, the RCRA corrective action and the CERCLA response action programs use parallel (but not identical) procedures.

OIL POLLUTION ACT OF 1990

The **Oil Pollution Act of 1990 (OPA)** amends section 311 of the Clean Water Act (CWA). Section 311 prohibits the discharge of oil and certain hazardous substances in quantities that may be harmful to public health or welfare (OPA revised this to include the environment). OPA established the Oil Spill Liability Trust Fund to pay for Federal responses to oil spills. Section 311 also authorizes the Oil Spill Prevention, Control, and Countermeasures (SPCC) program.

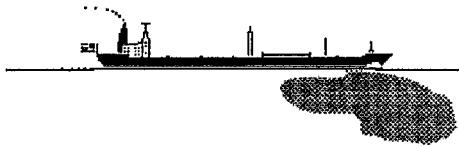

OPA is a comprehensive statute designed to: (1) expand the Federal role in response activities; (2) increase trust funds available for cleanup costs and other damages; (3) improve preparedness and response capabilities of Federal agencies and owners or operators of vessels and facilities; (4) ensure that responsible parties pay for damages from spills that do occur (subject to liability limits); (5) increase vessel safety through requirements for double hulls; and (6) establish an expanded oil pollution research and development effort.

Some of the most significant provisions of OPA include the following:

- **Expanded Federal Role in Response** — Under revised section 311(c) of the CWA, the Federal government is required to direct responses to releases that pose a substantial threat to the public health or welfare, and has the discretion to direct responses to any discharges threatening public health or welfare.
- **Oil Spill Liability Trust Fund** — OPA creates a new \$1 billion trust fund that is available for cleanup costs and other damages. The USCG administers the fund, which is used to pay for removal costs and damages resulting from an oil discharge. Fund monies are supplied by a five-cent per-barrel fee on oil.
- **Contingency Planning** — New section 311(j) of the CWA requires EPA and the USCG to enhance the existing National Response System by designating Area Committees to develop Area Contingency Plans to help ensure among other things the removal of a worst-case spill from a vessel or facility in or near the area covered by each area plan. Also, OPA added a new requirement in CWA section 311(j) that owners or operators of individual vessels and facilities (except onshore facilities that are not expected to cause substantial environmental harm from

OPA Provisions

- Expanded Federal Role
- Oil Spill Liability Trust Fund
- Contingency Planning
- Increased Liability and Civil Penalties
- Double Hulls
- Research and Development

oil discharges) prepare response plans for worst-case oil and hazardous substances discharges. The statute also requires amendments to the NCP, including development of a Fish and Wildlife Plan.

- **Increased Liability for Spills** — OPA increases the liability of tanker owners and operators, responsible parties at onshore facilities and deepwater ports, and holders of leases or permits for offshore facilities in the event of a spill. OPA broadens liability to cover not only removal costs and natural resource damages, but also the provision of spill-related health and safety services by State and local governments and losses of private property, revenues, subsistence use and profits.
- **Double Hulls** — Under OPA, newly constructed tankers over certain size limits must have double hulls or other double containment systems. Existing tankers without double hulls are to be phased out by size, age, and design beginning in 1995. Tankers over certain size limits without double hulls are banned after 2015.
- **Research and Development** — OPA mandates the establishment of an interagency committee to coordinate efforts to improve oil spill response technology.

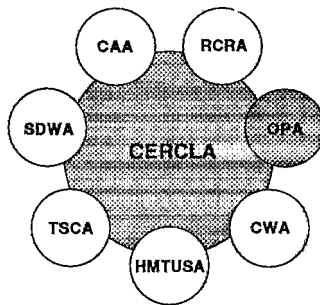

Primary Federal responsibility for implementing OPA rests with the United States Coast Guard (USCG) and EPA. The USCG is responsible for administering the trust fund, responding to coastal spills, reviewing contingency plans for vessels and transportation-related facilities, and coordinating research and development efforts along with other requirements. EPA's responsibilities include reviewing contingency plans for certain onshore facilities, responding to discharges occurring in the inland zone, and revising the NCP.

As with the Superfund program, the NCP serves as the regulatory blueprint that guides Federal response to oil spills.

How OPA and CERCLA Interact

OPA amends the CWA and includes a number of provisions regarding the prevention, control, and response to spills or threats of spills into U.S. waters from oil and CWA hazardous substances. The NCP provides the framework for CERCLA and CWA section 311 responses. CWA section 311

requires facilities storing oil and CWA hazardous substances to develop contingency plans, and to penalize facilities for non-compliance. CWA section 311(b) authorizes more stringent penalties for unauthorized spills of oil and/or hazardous substances and violations of the regulations. OPA provides that liability includes the cost of the response and damages to natural resources, property, and subsistence use of natural resources. These provisions are independent of CERCLA.

CLEAN WATER ACT



The **Clean Water Act (CWA)** was enacted to regulate and cleanup polluted waters in the United States. It is designed to ensure that the nation's waters are safe to the public and support fish and other aquatic life. Specifically, the CWA is designed to restore and maintain the chemical, physical, and biological integrity of the nation's waters.

The CWA was one of the major environmental laws passed by Congress in the 1970s. It provides EPA with two types of authority:

- **Regulatory** — to prevent and control discharges of pollutants into waters of the U.S.
- **Response** — to respond to releases of pollutants into waters of the U.S. Prior to CERCLA, EPA and USCG worked under the CWA to clean up releases of oil and hazardous substances into the navigable waters of the U.S.

The previous section on the OPA describes the authorities and provisions of CWA section 311. This section describes some of the major authorities and provisions of the other sections of the CWA.

The CWA requires that all direct discharges to surface water comply with technology-based discharge standards. These standards require the use of best practicable control technology (BPCT) for conventional pollutants (e.g., suspended solids, fecal coliform) and best available technology economically achievable (BAT) for toxic (e.g., benzene, chloroform) and non-conventional (e.g., ammonia, nitrogen, total solids) pollutants. EPA has published effluent guidelines for specific categories of industries. These guidelines are translated into specific effluent requirements in discharge permits.

The CWA requires a permit for any discharge into the nation's waterways. For waste water, only two discharge options are allowed:

- *Direct discharge* into surface water pursuant to a National Pollution Discharge Elimination System (NPDES) permit
- *Indirect discharge*, which means that the waste water is first sent to a publicly owned treatment works (POTW), and then after treatment by the POTW, discharged into surface water pursuant to an NPDES permit.

The NPDES permit is granted on a case-by-case basis and the terms of the permit depend on a number of variables. Essentially, the NPDES permit limits the permissible concentration of toxic constituents or conventional pollutants in effluents discharged to a waterway.

If the indirect discharge option is chosen, the generator of the waste water cannot simply transfer the pollutants to a POTW. Rather, the waste water must satisfy applicable pretreatment standards, where they exist.

Section 304 of the CWA directs EPA to publish water quality criteria for specific pollutants. EPA develops two types of criteria: one for the protection of human health and another for protection of aquatic life. EPA has published a total of 82 water quality criteria. These criteria are non-enforceable guidelines used by States to set water quality standards for surface water. Section 303 requires States to develop water quality standards, based on Federal water quality criteria, to protect existing or attainable uses (e.g., recreation, water supply) of surface waters.

How the CWA and CERCLA Interact

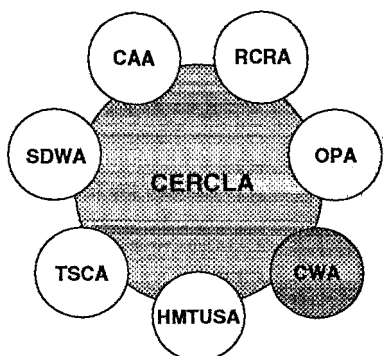

The CWA-designated hazardous substances are incorporated into the CERCLA definition of hazardous substances. The CWA section has authority for responding to discharges of oil into the waters of the U.S.. The CWA section 311 and CERCLA have similar response authorities for responding to discharges of CWA hazardous substances released into U.S. waters. In addition, CERCLA provides response authority for responding to discharges of other hazardous substances, pollutants, and contaminants into the environment. The NCP, the blueprint for managing responses

to releases, governs both CWA and CERCLA responses. The previous section on OPA provides a more detailed discussion of how CWA section 311 and CERCLA interact.

On-site CERCLA responses must comply with or waive substantive requirements of Federal and State environmental laws that are determined to be ARARs. CWA and State discharge and water quality standards may be ARARs for onsite remedial actions at Superfund sites. The application of CWA and State ARARs is determined on a case-by-case basis. CERCLA responses conducted entirely on-site do not require CWA permits.

CLEAN AIR ACT

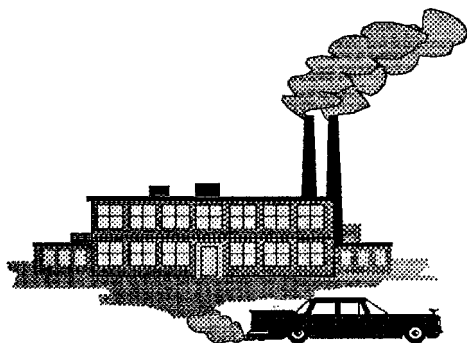

The **Clean Air Act (CAA)** was the first major environmental law passed by Congress. The CAA was enacted to limit the emission of pollutants into the atmosphere to protect human health and the environment from the effects of airborne pollution. The CAA authorizes EPA to achieve this objective by setting air quality standards and regulating emissions of pollutants into the air. EPA has established emission standards for mobile (e.g., automobiles) and stationary (e.g., factories) sources of pollutant emission. These are implemented through Federal, State, and local programs.

For six pollutants, EPA has established National Ambient Air Quality Standards (NAAQS). Regulation of these six pollutants affords the public some protection from toxic air pollutants. Primary responsibility for meeting the requirements of the CAA rests with States, who must submit State Implementation Plans (SIPs) to achieve and maintain the NAAQS. Pursuant to the SIP, new or modified stationary sources of air emissions must undergo pre-construction review to determine whether the facility will interfere with attainment or maintenance of NAAQS. In addition, in some areas that do not attain NAAQS, SIPs must contain regulatory strategies to control emissions from existing stationary sources. SIPs, not NAAQS, are potential ARARs. Of chief concern to Superfund are the requirements that apply to sources of volatile organic compounds (VOCs) and other toxic air pollutants (e.g., heavy metals).

Section 112 of the CAA directs EPA to identify hazardous air pollutants and to establish emission standards for sources that emit the pollutants. These standards, known as National

Emission Standards for Hazardous Air Pollutants (NESHAPS), apply to new as well as existing sources. Additionally, under section 112(r), the accidental release provisions of the CAA, facilities are required to provide information on the ways they manage risk posed by certain substances listed by EPA and indicate what they are doing to minimize risk to the community from those chemicals.

How the CAA and CERCLA Interact

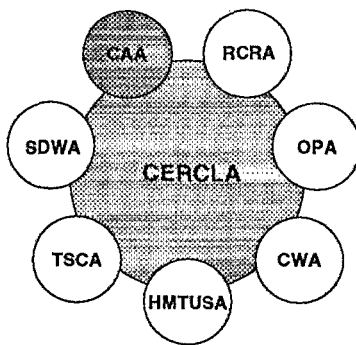

The CAA and CERCLA interact in the following two ways:

- The CAA hazardous air pollutants are included as CERCLA hazardous substances
- CAA emissions limitations provide substantive standards for CERCLA responses.

CERCLA provides Federal response authority to address releases of air pollutants that threaten human health or the environment. CAA requirements may apply to CERCLA responses.

The accidental release provisions of CAA requires the establishment of a list of at least 100 regulated substances and thresholds under section 112. Sixteen of these substances were identified in the CAA for inclusion on the list. The rest of the list maybe drawn from, but not necessarily limited to, the list of extremely hazardous substances under SARA Title III.

CAA hazardous air pollutants, identified under section 112, are CERCLA hazardous substances by definition. Other CAA air pollutants, identified under sections 109 and 111, are not covered by the CERCLA definition of hazardous substances but may be covered by the CERCLA definition of "pollutant or contaminant."

CAA emissions limitations provide substantive standards for CERCLA responses in two ways. CAA emissions limitations provide triggers for Superfund action (i.e., if baseline conditions (pre-cleanup) exceed air standards, action may be warranted). And, these limitations provide cleanup standards to attain in addressing unremediated conditions, and emission standards for certain cleanup technologies

employed. CAA emission standards may be ARARs for onsite response actions at Superfund sites. The application of CAA standards as ARARs is determined on a case-by-case basis.

CERCLA responses need not comply with CAA permit requirements.

SAFE DRINKING WATER ACT

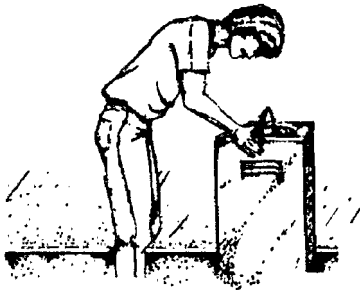

The **Safe Drinking Water Act (SDWA)** was enacted in 1974 to protect human health by protecting the quality of the nation's drinking water supply. It protects drinking water sources by regulating facilities or systems that inject fluids into the ground, and protects public drinking water consumers by regulating the quality of water distributed by public water systems. These goals are achieved by authorizing the establishment of:

- C Drinking water standards
- C A permit program for the underground injection of wastes
- C Resource planning programs.

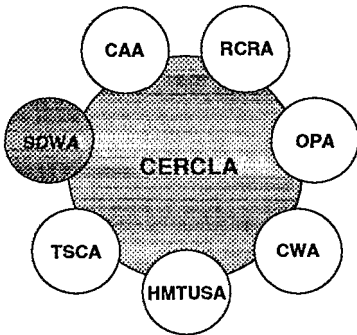

Both surface and underground public drinking water sources are thereby protected by the SDWA.

The SDWA imposes requirements on persons who own or operate a system which has at least 15 service connections or 25 consumers, and provides piped water for human consumption. The regulations which implement these requirements are entitled the National Primary Drinking Water Regulations (NPDWR). All water suppliers must periodically sample the water delivered to users and record and report their findings to EPA or the State, whichever is appropriate.

The Underground Injection Control (UIC) program protects underground sources of drinking water from contamination by injection of waters or wastes into injection wells. A permit program limits substances that may be injected and how they may be injected.

EPA currently administers the SDWA public water system program in only two states, Indiana and Wyoming. In all other states, EPA oversees State implementation, but retains independent enforcement authority.

How the SDWA and CERCLA Interact

Provisions of the SDWA apply to CERCLA site discharges to public drinking water sources. SDWA provisions such as Maximum Contaminant Levels (MCLs) may be applicable to CERCLA cleanup of water that may be used for drinking.

TOXIC SUBSTANCES CONTROL ACT

The **Toxic Substances Control Act (TSCA)**, signed into law in October 1976, provides EPA with broad authority to regulate chemicals and chemical substances whose manufacture, processing, distribution in commerce, use or disposal may present an unreasonable risk of injury to health or the environment. TSCA was enacted to keep harmful chemicals out of the environment and to fill the gaps in existing environmental laws in the areas of toxic substances.

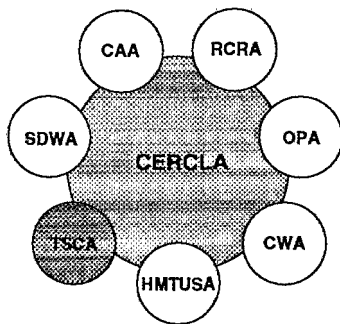

TSCA deals with all chemical substances planned for production, produced, imported, or exported from the country. TSCA applies primarily to manufacturers, distributors, processors, and importers of chemicals. TSCA provides authorities to control the manufacture and sale of certain chemical substances. These authorities include

- C Testing of chemicals currently in commercial production or use
- C Pre-market screening and regulatory tracking of new chemical products
- C Controlling unreasonable risks once a chemical substance is determined to have an adverse effect on health or the environment. These powers include:
 - % Prohibiting the manufacture or certain uses of the chemical
 - % Requiring labeling with specific markings or warnings
 - % Limiting volume of production or concentration
 - % Requiring recordkeeping about production
 - % Requiring replacement or re-purchase of products
 - % Controlling disposal methods.

The only exceptions to these authorities are pesticides (which are regulated under the Federal Insecticide, Fungicide and Rodenticide Act), tobacco or tobacco products, source material by-products or special nuclear material (as defined by the Atomic Energy Act), and food, food additives, drugs, and cosmetics (regulated under the Food, Drug and Cosmetic Act).

How TSCA and CERCLA Interact

TSCA and CERCLA commonly interact if polychlorinated biphenyls (PCBs) are involved in a CERCLA response. PCB disposal regulations under TSCA may apply, as ARARs, at Superfund sites. PCBs are the only chemical identified by Congress by name for direct regulation under TSCA. TSCA regulations of other chemicals may also present possible ARARs, depending on the type of hazardous substances at a Superfund site.

TOXIC SUBSTANCES CONTROL ACT

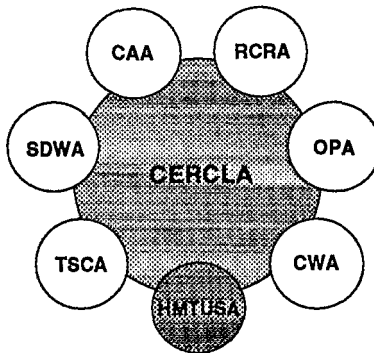

The Hazardous Materials Transportation Uniform Safety Act of 1990 (HMTUSA), section 117, evolved from the emergency preparedness proposal developed by DOT, FEMA, EPA, DOL, and DOE, and presented to the Congress during the legislative process to reauthorize the Hazardous Materials Transportation Act of 1975. The requirements of the HMTUSA were designed to allow the federal government or provide national direction and guidance to enhance hazardous materials emergency preparedness activities at the State and local levels. This will be accomplished by ensuring comprehensive, integrated, and coordinated planning, training, and technical assistance programs. Section 117, "Public Sector Training and Planning," was specifically crafted to build upon and enhance the existing framework and working relationships established within CERCLA/Superfund for the National Response Team (NRT), Regional Response Teams (RRTs), and the Title III State Emergency Response Commission.

How HMTUS and CERCLA Interact

HMTUSA builds on existing programs and relationships and, in fact, specifically requires grant money to be submitted to LEPCs as established under SARA Title III. Specifically, HMTUSA provides for:

- (1) Planning grants (\$5 million per year from 1993 through 1998) to develop, improve, and implement SARA Title III local emergency response plans and to determine the need for regional hazardous materials emergency response teams.

States will receive these grants by agreeing to submit at least 75% of their planning grants money directly to LEPCs to develop, improve, and implement their emergency plans.

- (2) Training grants (\$7.8 million per year from 1993 through 1998) for delivery of training to public sector employees in hazardous materials response. This grant could be used for hazardous material waste and emergency response and other training activities. However, in order to qualify for the training grants, States/Tribes must certify they are in compliance with section 301 and 303 of SARA Title III.

SECTION XIV

FUTURE DIRECTIONS OF THE SUPERFUND PROGRAM

- **OVERVIEW**
- **SUPERFUND ACCELERATED CLEANUP MODEL**

OVERVIEW

During the first ten years of the Superfund program, EPA successfully developed a program that brought the United States to a new level of understanding about hazardous substances and how they can be treated. The Superfund program is comprehensive, yet flexible and innovative. Its mission is both immediate and long-range. Its focus is specific enough to handle individual site cleanups with precision, yet broad enough to encourage advances in a relatively new scientific and technical field.

Superfund already has resulted in permanent solutions to many hazardous waste problems. However, after the first 10 years of experience, it is apparent to Superfund program participants that the program faces a workload stretching well into the next century. The hazardous waste problem in the United States remains large, complex, and long-term.

EPA is looking ahead to project a program for the future. Long-term planning is important because, for example, EPA estimates indicate that the cleanup of sites on the NPL, as of 1991, is expected to cost an additional \$19 billion beyond the amount already obligated. Also, EPA expects the number of NPL sites to grow from 1,200 to 2,000 by the end of the century.

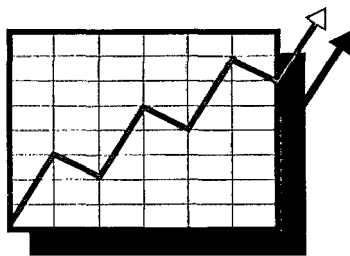

"**Superfund 2000**" represents EPA's strategy for responding to long-term needs. As part of this concept, EPA is conducting studies of the possible universe of sites to be cleaned up by Superfund or other parties. One study involves the development of a liability model to help estimate possible future cleanup costs under different scenarios. EPA also is looking at past remedy selection decisions and evaluating patterns that may indicate future useful technologies. In addition, opportunities for greater program integration, particularly between the Superfund and Resource Conservation and Recovery Act (RCRA) programs, are being assessed.

In keeping with EPA's goal of increasing multimedia enforcement efforts, EPA is examining the future role of responsible parties and State and local governments in the

Superfund program. All these studies and activities will ensure that an integrated, practical, viable, and results-oriented Superfund program will continue to evolve.

SUPERFUND ACCELERATED CLEANUP MODEL

In February of 1992, the EPA Administrator signed a plan aimed at moving sites more quickly through the Superfund process to cleanup and redefining the way progress is measured. This new plan, called the **Superfund Accelerated Cleanup Model (SACM)**, is designed to include substantial, prioritized risk reduction in shorter time frames and better communication of program accomplishments to the public.

As outlined in this manual, the current system for Superfund cleanups is based on two discrete programs — removal and remedial. Under SACM, this distinction would be retained, but EPA would view **both** removal and remedial actions as **Superfund** actions. Rather than viewing these two entities as separate programs, they are viewed as separate legal authorities with different, but complementary, application at Superfund sites.

An integral part of SACM is the combined site assessment. The **single site assessment function** would address, in a coordinated fashion, requirements for removal assessments, preliminary assessments / site inspections (PA/SIs), remedial investigations / feasibility studies (RI/FSs), and risk assessments. Discovered sites could be screened once and, if they are considered to have a serious level of contamination, go directly to the remedial investigation and risk assessment phases of cleanup. Such a change could cut the current process by several years.

During the assessment process, a **Regional Decision Team** would decide to place a site on either an "**Early Action List**" or a "**Long Term Remediation List**" or both. Early Actions are short-term, quickly implemented cleanups that would be completed in three to five years. Early Actions will include time-critical and non-time-critical removal activities, as well as remedial actions, and will be designed to address all short-term threats to public health and safety. Under SACM, such actions would be combined immediately with public participation and expedited enforcement actions. Long Term Remediation sites would only include sites requiring cleanup over many years (e.g., ground water restoration, sites involving property acquisition, long-term operation and maintenance,

or mining sites, extended incineration projects, and wetlands/estuaries).

SACM introduces the concept of Regional Decision Teams that would combine the cross-programmatic skills and experience of On-Scene Coordinators, Remedial Project Managers, Office of Regional Counsel attorneys, site and risk assessors, and Community Relations Coordinators. As explained above, the Regional Decision Team would be responsible for expediting sites onto the Early Action List and scoring long-term restoration actions for inclusion on the NPL.

A key objective of SACM is to count the **totality of risk reduction** rather than focus on NPL site deletions. This would be a fundamentally new way for the Superfund program to measure its success, and would show the public how Superfund is achieving appropriate cleanup at a large number of sites.

Regional pilot tests are underway. The model is being further refined, and EPA is developing protocols and guidance that will expedite the implementation of SACM. The steps for the new Superfund process are illustrated in Exhibit 8.

EPA is proud of its hard-won accomplishments in the Superfund program, and will continue to use new management and technological approaches to significantly improve human health and the environment, accelerate the pace of cleanup, expand its efficiency and activity, improve the quality of the program over time, and build public confidence. There are no miracle cures for the hazardous waste problem, but EPA has a clear strategy for meeting this challenge.

Exhibit 8 The SACM Process

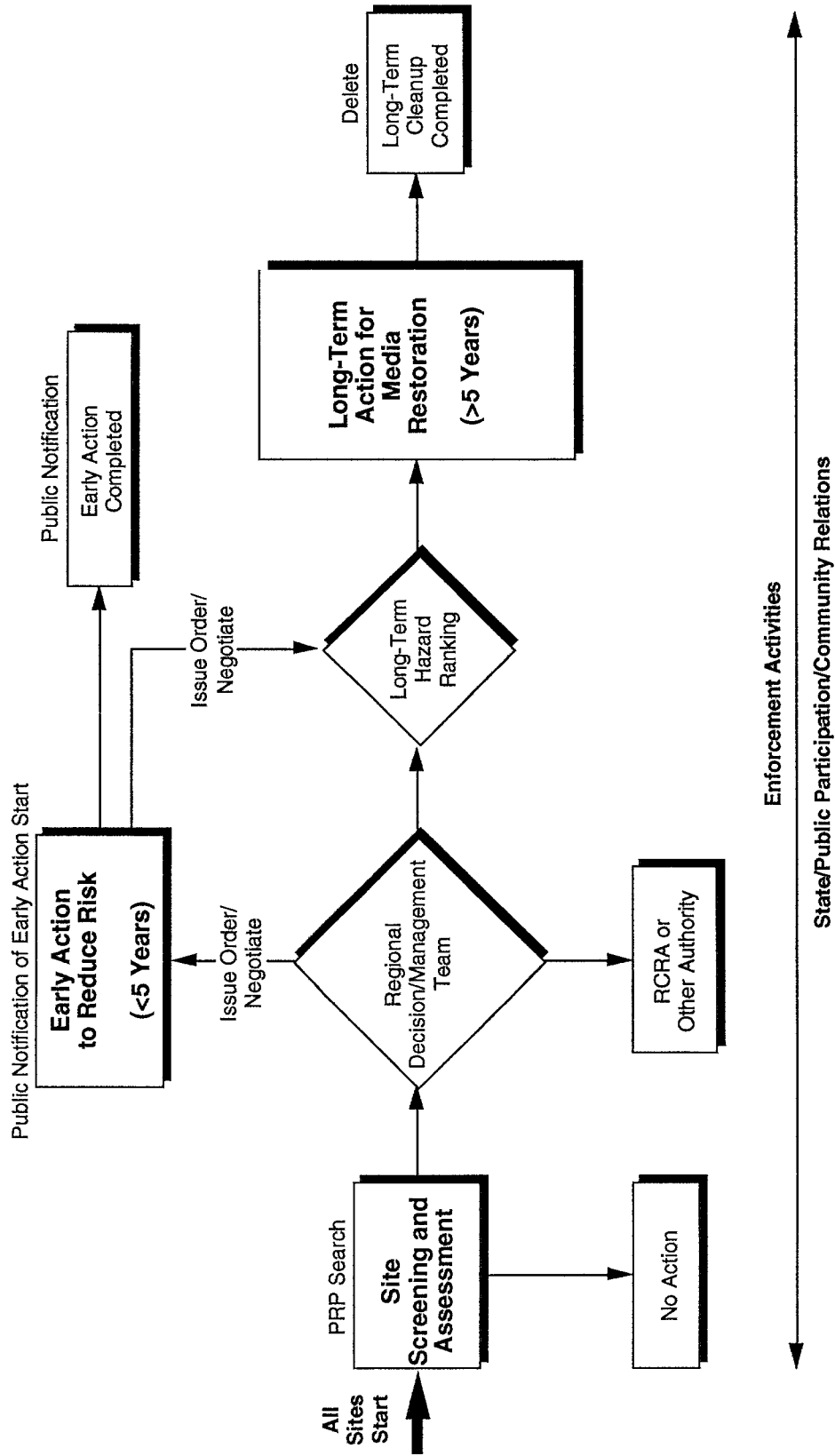

APPENDIX A

**RESOURCE FOR SUPERFUND
PROGRAM PUBLICATIONS**

APPENDIX A

RESOURCE FOR SUPERFUND PROGRAM PUBLICATIONS

Compendium of Superfund Program Publications - 1992 EPA/OERR

EPA/540/8-91/014
Publication 9200.7-02B
November 1991

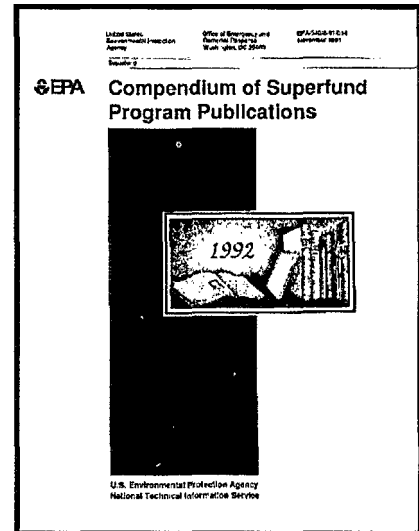

The Compendium is the single most complete source of information produced by the U.S. Environmental Protection Agency (EPA) on Superfund. The publications and computerized data listed in the Compendium come from many program offices. Chief among them is the Office of Emergency and Remedial Response (OERR). Other EPA offices which produced documents listed in the Compendium include the:

- Technology Innovation Office (TIO)
- Office of Waste Programs Enforcement (OWPE)
- Office of Air Quality Planning and Standards (OAQPS)
- Office of Research and Development (ORD).

The Superfund program has endeavored to place the entire historical collection, as well as all new documents, in the Compendium. Documents related to enforcement of the Resource Conservation and Recovery Act (RCRA) are also included, because many enforcement actions combine aspects of RCRA and Superfund.

The Compendium includes the following information in each abstract:

- Document title
- Publication date
- Icon showing the type of document (*e.g., fact sheet, directive, publication, or computer material*)
- Originating office
- Document length
- Brief summary of document contents

- Agency control numbers
- NTIS order number
- NTIS price code.

For those unfamiliar with the Superfund program, wherever possible, plain English has been substituted for program jargon and acronyms. Also, the Compendium includes a subject index, title index, and numerical indexes. For users with Superfund expertise, the summaries in the abstracts section have been organized under 10 large categories and further organized into specific subcategories.

The Compendium may be obtained free of charge from the National Technical Information Service (NTIS): 5285 Port Royal Road, Springfield, VA 22161; (703) 487-4650.

APPENDIX B
EPA ORGANIZATIONAL CHARTS

APPENDIX B

EPA ORGANIZATIONAL CHART

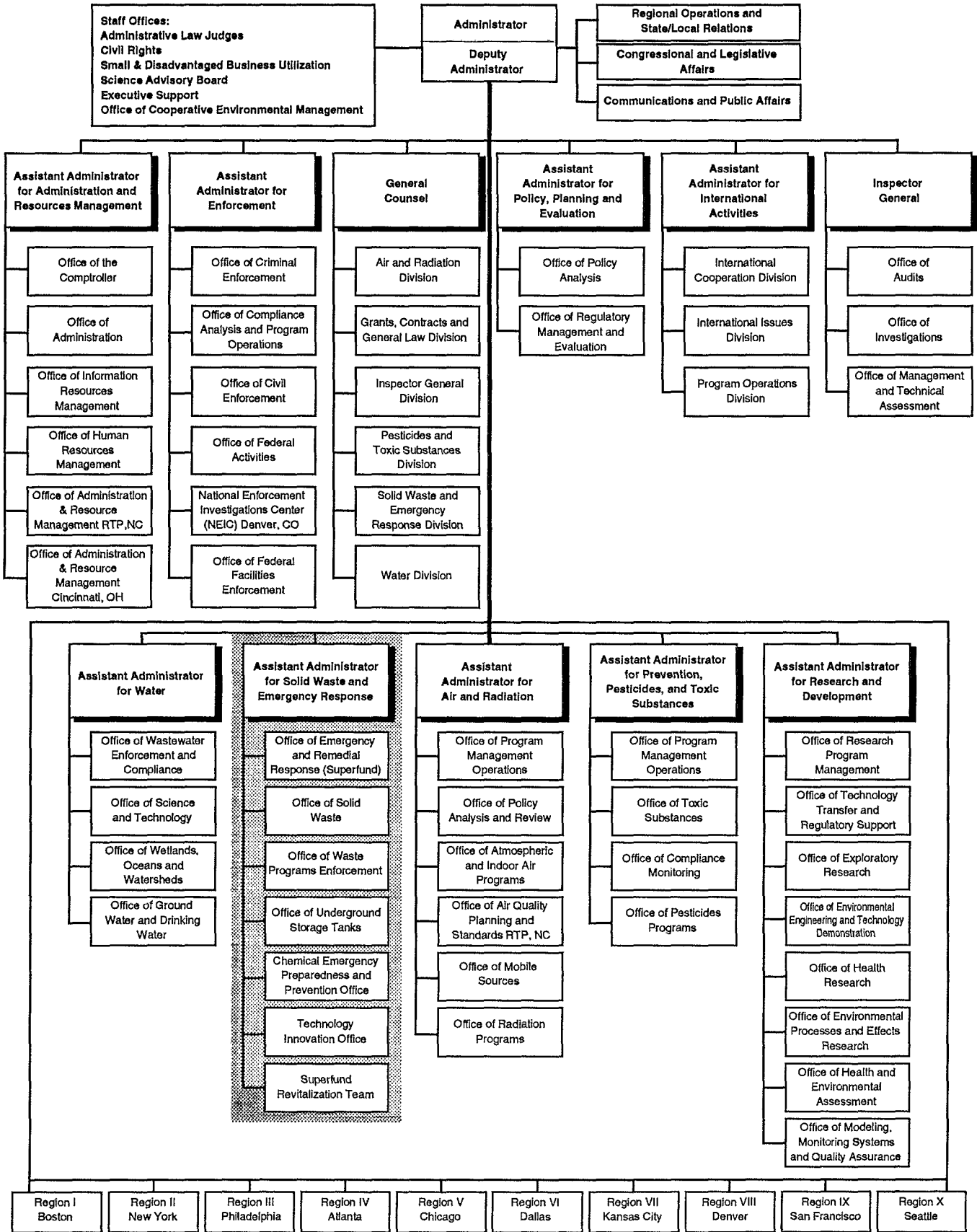

OFFICE OF SOLID WASTE AND EMERGENCY RESPONSE (OSWER) ORGANIZATIONAL CHART

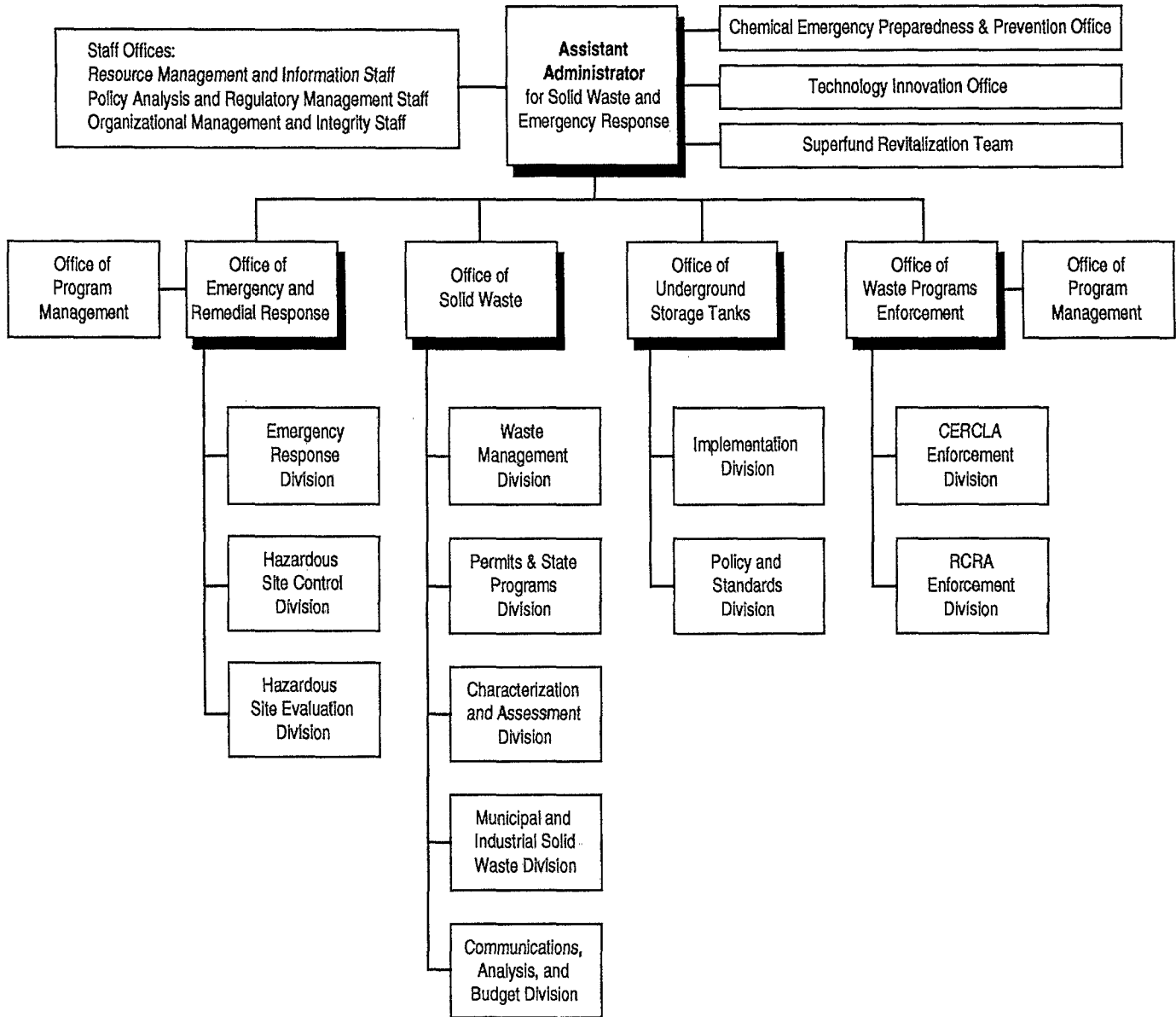

**OFFICE OF EMERGENCY AND REMEDIAL RESPONSE
ORGANIZATIONAL CHART AND ROLES**

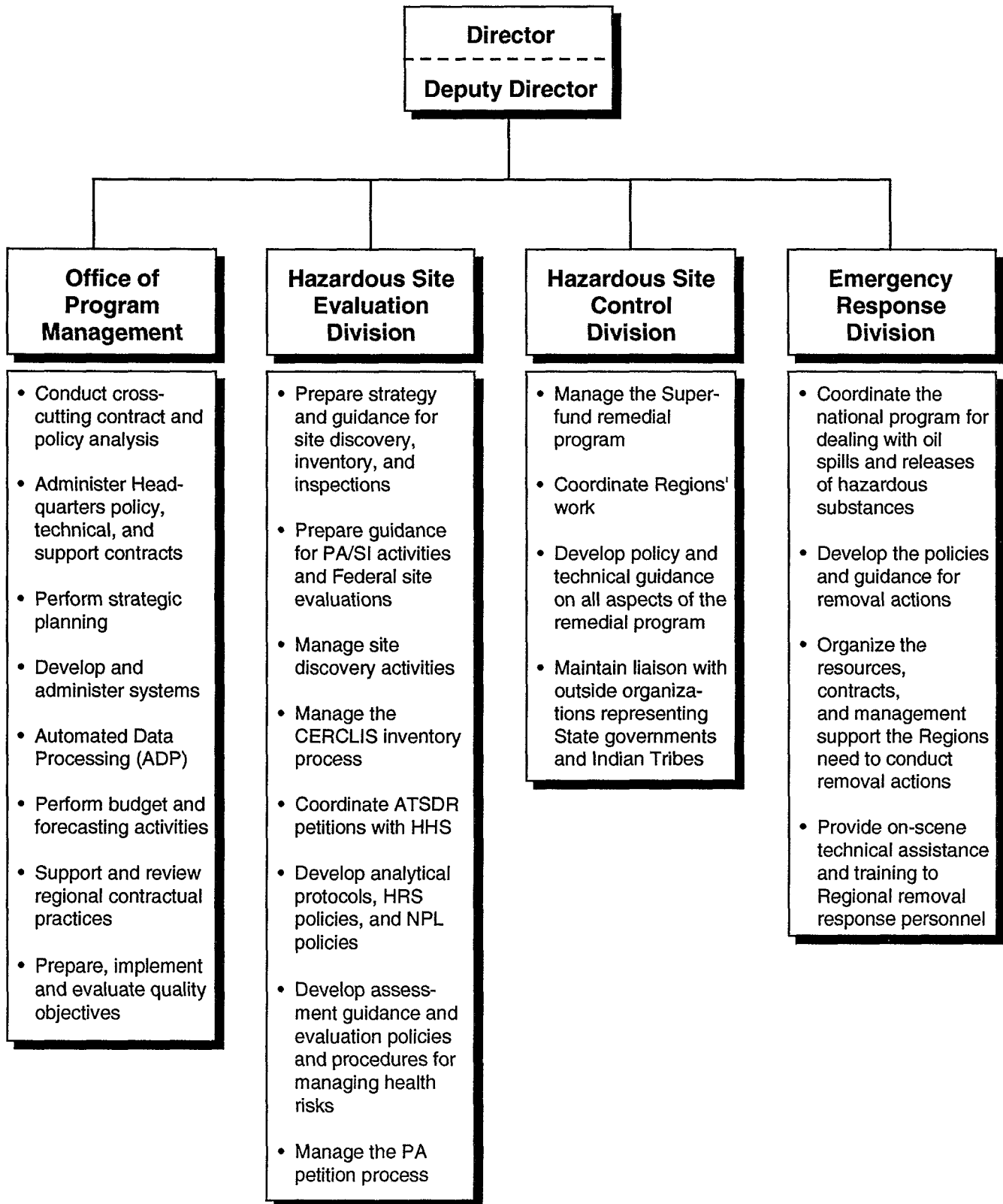

APPENDIX C

EPA REGIONAL OFFICE DIRECTORY

APPENDIX C

EPA REGIONAL OFFICE DIRECTORY

Region 1

Environment Protection Agency
John F. Kennedy Federal Building
One Congress Street
Boston, MA 02203
(617) 565-3420

Environmental Services Division
60 Westview Street
Lexington, MA 02173
(617) 860-4300

Region 2

Environmental Protection Agency
Jacob K. Javitz Federal Building
26 Federal Plaza
New York, NY 10278
(212) 264-2657

Environmental Service Division
2890 Woodbridge Avenue
Raritan Depot Building 10
Edison, NJ 08837-3679
(908) 321-6754

Region 3

Environmental Protection Agency
841 Chestnut Building
Philadelphia, PA 19107
(215) 597-9800

Region 4

Environmental Protection Agency
345 Courtland Street, N.E.
Atlanta, GA 30365
(404) 347-4727

Region 5

Environmental Protection Agency
77 West Jackson Boulevard
Chicago, IL 60604
(312) 886-9851

Region 6

Environment Protection Agency
First Interstate Bank Tower at Fountain Place
1445 Ross Avenue, 12th Floor, Suite 1200
Dallas, TX 75202-2733
(214) 655-6444

Environmental Service Division
Houston Branch Office
10625 Fallstone Road
Houston, TX 7099
(713) 983-2200

Region 7

Environmental Protection Agency
726 Minnesota Avenue
Kansas City, KS 66101
(913) 551-7000

Environmental Services Division
25 Funston Road
Kansas City, KS 66115
(913) 551-5000

Region 8

Environmental Protection Agency
999 18th Street, Suite 500
Denver, CO 80202-2405
(303) 293-1603

Region 9

Environmental Protection Agency
75 Hawthorne Street
San Francisco, CA 94105
(415) 744-1305

Region 10

Environmental Protection Agency
1200 Sixth Avenue
Seattle, WA 98101
(206) 553-4973

States by EPA Region

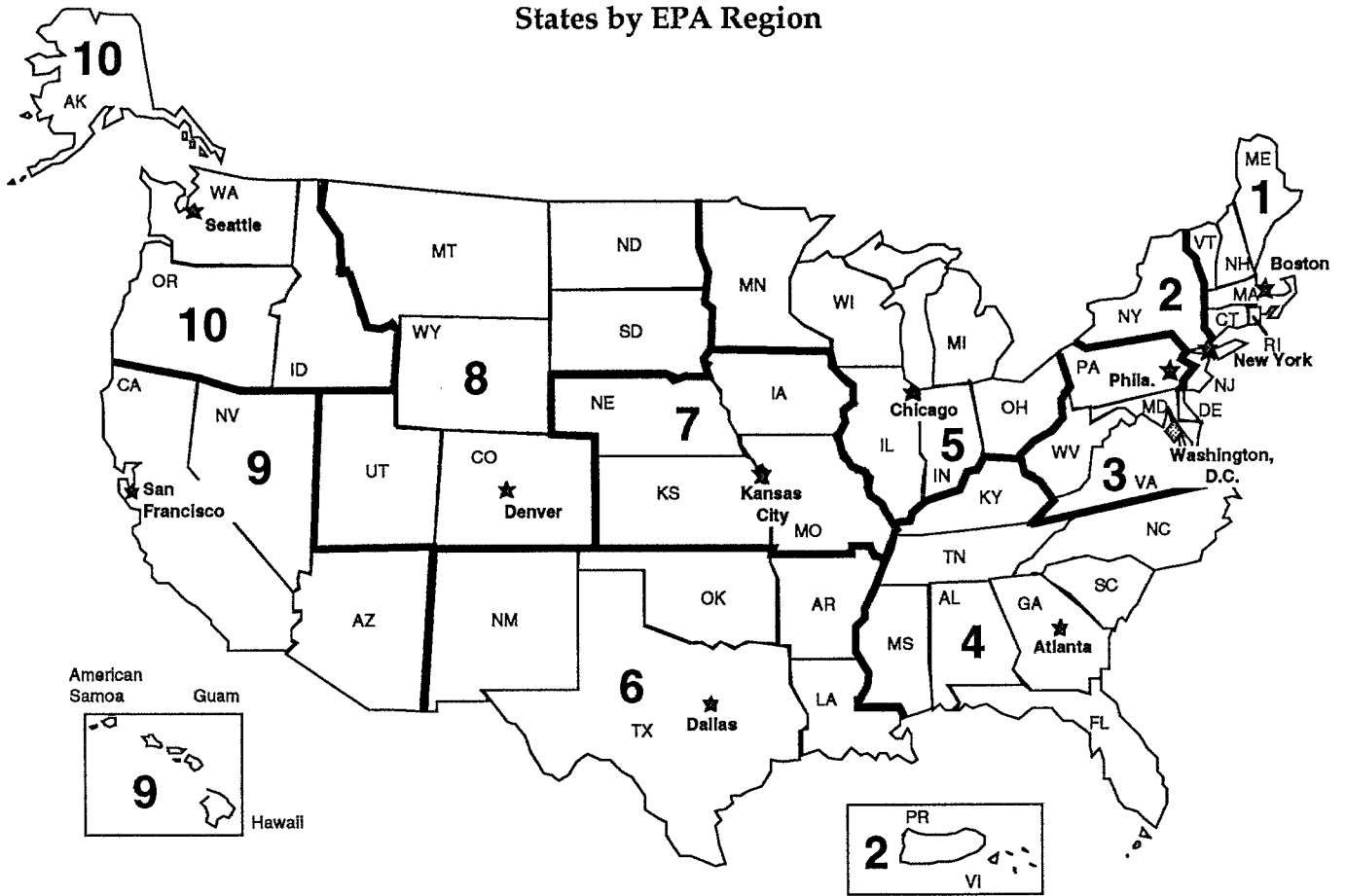

Region

- 4 – Alabama
- 10 – Alaska
- 9 – Arizona
- 6 – Arkansas
- 9 – California
- 8 – Colorado
- 1 – Connecticut
- 3 – Delaware
- 3 – District of Columbia
- 4 – Florida
- 4 – Georgia
- 9 – Hawaii
- 10 – Idaho
- 5 – Illinois
- 5 – Indiana
- 7 – Iowa
- 7 – Kansas
- 4 – Kentucky
- 6 – Louisiana
- 1 – Maine

Region

- 3 – Maryland
- 1 – Massachusetts
- 5 – Michigan
- 5 – Minnesota
- 4 – Mississippi
- 7 – Missouri
- 8 – Montana
- 7 – Nebraska
- 9 – Nevada
- 1 – New Hampshire
- 2 – New Jersey
- 6 – New Mexico
- 2 – New York
- 4 – North Carolina
- 8 – North Dakota
- 5 – Ohio
- 6 – Oklahoma
- 10 – Oregon
- 3 – Pennsylvania
- 1 – Rhode Island

Region

- 4 – South Carolina
- 8 – South Dakota
- 4 – Tennessee
- 6 – Texas
- 8 – Utah
- 1 – Vermont
- 3 – Virginia
- 10 – Washington
- 3 – West Virginia
- 5 – Wisconsin
- 8 – Wyoming
- 9 – American Samoa
- 9 – Guam
- 2 – Puerto Rico
- 2 – Virgin Islands

APPENDIX D

CERCLA/SUPERFUND PROGRAM ACRONYMS

APPENDIX D

CERCLA/SUPERFUND PROGRAM ACRONYMS

AA	Assistant Administrator
AO	Administrative Order
AOC	Administrative Order on Consent
ARAR	Applicable or Relevant and Appropriate Requirement
ARCS	Alternative Remedial Contracting Strategy
ATSDR	Agency for Toxic Substances and Disease Registry
ATTIC	Alternative Treatment Technology Information Center
BAT	Best Available Technology
BCT	Best Control Technology
CA	Cooperative Agreement
CAA	Clean Air Act
CD	Consent Decree
CED	CERCLA Enforcement Division
CEPP	Chemical Emergency Preparedness Program
CERCLA	Comprehensive Environmental Response, Compensation, and Liability Act
CERCLIS	Comprehensive Environmental Response, Compensation, and Liability Information System
CERI	Center for Environmental Research Information
CLP	(National) Contract Laboratory Program
CR	Community Relations
CRC	Community Relations Coordinator
CRP	Community Relations Plan

CWA	Clean Water Act
DO	Delivery Order
DQO	Data Quality Objective
EPA	Environmental Protection Agency
EPCRA	Emergency Preparedness and Community Right-to-Know Act
ERCS	Emergency Response Cleanup Services
ERD	Emergency Response Division
ERNS	Emergency Response Notification System
ERT	Emergency Response Team
ESAT	Environmental Services Assistance Team
ESD	Explanation of Significant Differences
FEMA	Federal Emergency Management Agency
FIFRA	Federal Insecticide, Fungicide, Insecticide, and Rodenticide Act
FIT	Field Investigation Team
FS	Feasibility Study
FWPCA	Federal Water Pollution Control Act
HHS	(Department of) Health and Human Services
HRS	Hazard Ranking System
HSCD	Hazardous Site Control Division
HSED	Hazardous Site Evaluation Division
HSWA	Hazardous and Solid Waste Amendments
IAG	Interagency Agreement
IRIS	Integrated Risk Information System
LDR	Land Disposal Restrictions

LEPC	Local Emergency Planning Committee
LGR	Local Government Reimbursement
LS1	Listing Site Investigation
LUST	Leaking Underground Storage Tank
MCL	Maximum Contaminant Level
MCLG	Maximum Contaminant Level Goals
MOA	Memorandum of Agreement
MOU	Memorandum of Understanding
MSDS	Material Safety Data Sheets
NAAQS	National Ambient Air Quality Standards
NAWQC	National Ambient Water Quality Criteria
NCP	National Oil and Hazardous Substances Pollution Contingency Plan
NESHAPs	National Emission Standards for Hazardous Air Pollutants
NPDES	National Pollution Discharge Elimination System
NPDWR	National Primary Drinking Water Regulations
NPL	National Priorities List
NRC	National Response Center
NRT	National Response Team
NTIS	National Technical Information Service
O&M	Operations and Maintenance
OARM	Office of Administration and Resources Management
OE	Office of Enforcement
OERR	Office of Emergency and Remedial Response
OGC	Office of General Counsel

OIRM	Office of Information Resources Management
OPA	Oil Pollution Act of 1990
ORC	Office of Regional Counsel
ORD	Office of Research and Development
ORO	Office of Regional Operations
OSC	On-Scene Coordinator
OSW	Office of Solid Waste
OSWER	Office of Solid Waste and Emergency Response
OU	Operable Unit
OWPE	Office of Waste Programs Enforcement
OSHA	Occupational Safety and Health Administration
PA	Preliminary Assessment
PA/Si	Preliminary Assessment/Site Inspection
PCB	Polychlorinated Biphenyl
POLREP	Pollution Report
POTW	Publicly-Owned Treatment Works
PP	Proposed Plan
PRP	Potentially Responsible Party
QA	Quality Assurance
QA/QC	Quality Assurance/Quality Control
QAPP	Quality Assurance Project Plan
R&D	Research and Development
RA	Remedial Action
RA	Regional Administrator

RAC	Response Action Contractor
RC	Regional Counsel
RCRA	Resource Conservation and Recovery Act
RD	Remedial Design
REAP	Regional Enforcement Activities Plan
RI	Remedial Investigation
RI/FS	Remedial Investigation/Feasibility Study
RMCL	Recommended Maximum Contaminant Levels
ROD	Records of Decision
RODS	Records of Decision System
RP	Responsible Party
RPM	Remedial Project Manager
RPO	Regional Project Officer
RQ	Reportable Quantity
RRC	Regional Response Center
RRT	Regional Response Team
RSE	Removal Site Evaluation
SACM	Superfund Accelerated Cleanup Model
SAP	Sampling and Analysis Plan
SARA	Superfund Amendments and Reauthorization Act of 1986
SCAP	Superfund Comprehensive Accomplishments Plan
SDWA	Safe Drinking Water Act
SEA	Site Evaluation Accomplished
SERC	State Emergency Response Commission

SI	Site Inspection
SIP	State Implementation Plan
SITE	Superfund Innovative Technology Evaluation (Program)
SITS	Site Investigation Tracking System
SMOA	Superfund Memorandum of Agreement
SOW	Statement of Work
SPCC	Spill Prevention Control Countermeasures
SSC	Superfund State Contract
SSI	Screening Site Investigation
TAG	Technical Assistance Grant
TAT	Technical Assistance Team
TCLP	Toxicity Characteristic Leaching Procedure
TQM	Total Quality Management
TSCA	Toxic Substance Control Act
TSD	Treatment, Storage, and Disposal
UAO	Unilateral Administrative Order
UIC	Underground Injection Control
USCG	U.S. Coast Guard
UST	Underground Storage Tank
VE	Value Engineering
VOC	Volatile Organic Compound
WA	Work Assignment

- G **Section I - Introduction to the Superfund Program**

- G **Section II - Superfund Regulatory Framework**

- G **Section III - Superfund Process**

- G **Section IV - Enforcement Program**

- G **Section V - Removal Actions**

- G **Section VI - Site Assessment**

- G **Section VII - Remedial Actions**

- G **Section VIII - State and Indian Tribal Involvement**

- G **Section IX - Federal Facilities**

- G **Section X - Community Relations/Public Participation**

- G **Section XI - Management and Technical Infrastructure**

- G **Section XII - Applicable or Relevant and Appropriate Requirements**

- G **Section XIII - CERCL's Relationship to Other Legislation**

- G **Section XIV - Future Directions of the Superfund Program**